

ESP
Series

Sabrina Sopranzi

FLASH on English

for MECHANICS, ELECTRONICS
& TECHNICAL ASSISTANCE

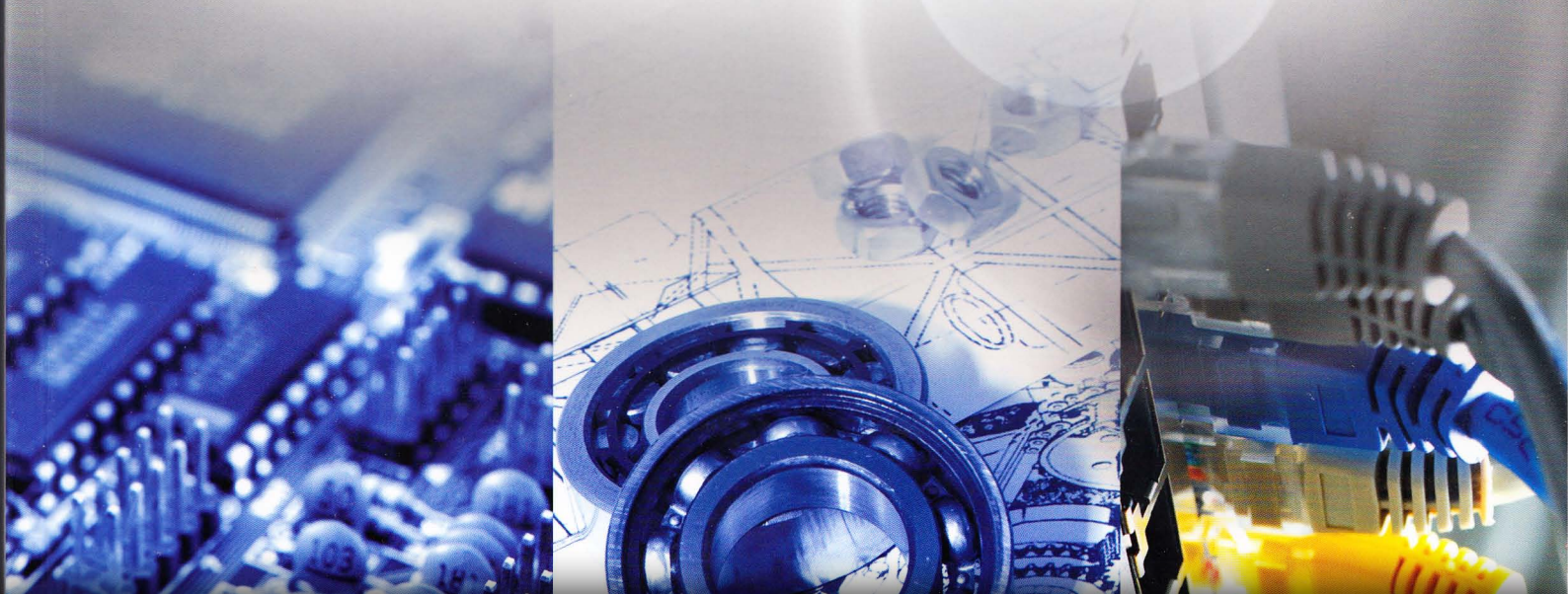

vk.com/englishlibrary



MP3 Audio Files



ESP
Series

Sabrina Sopranzi

FLASH

on English

for MECHANICS, ELECTRONICS
& TECHNICAL ASSISTANCE



Contents

Unit	Topic	Vocabulary	Skills
1 pp. 4-7	Materials	Types of materials: qualities, costs and properties Metal processes	Reading: properties of materials; basic metal processes Listening: descriptions of materials and metal processes Speaking: exchanging information about the qualities of materials Writing: a summary of the main types of materials
2 pp. 8-9	Technical drawing	Technical drawing tools Computer aided design system (CAD) Computer aided manufacturing program (CAM)	Reading: the basic tools of the drafter; from manual drawing to computerised drawing Listening: description of CAD/CAM systems
3 pp. 10-11	Machine tools	Machine tools: features and applications Computerised numerical control machines (CNC)	Reading: main features of machine tools; application of CNC machines to manufacturing processes Listening: automation of machine tools in manufacturing processes Writing: completing a table about the main features of metalworking processes
4 pp. 12-13	What is electricity?	Basic atomic structure Electricity and units of measurement Conductivity of materials	Reading: the atomic structure; types of current; units of measurement of electric current Listening: properties of conductors, semiconductors and insulators Writing: describing the main features of the atomic structure
5 pp. 14-15	Electric circuits	Circuit components Types of electric circuits Fuses and protective devices	Reading: description of the main circuit components; safety devices Listening: types of circuits Writing: describing the basic circuit components
6 pp. 16-19	How energy is produced	Conventional power plants Alternative power sources Electrical distribution system	Reading: types of power plants; alternative power sources Listening: different steps in the electrical distribution system Writing: completing a table about the advantages and disadvantages of alternative power sources Speaking: discussing the results of a quiz on energy saving
7 pp. 20-22	What is electronics?	Main electronic inventions Electronic circuits Mobile phones and radio signals	Reading: short history of the main inventions in electronics; types of electronic circuits Listening: mobile phones and radio signals Writing: describing the main advantages and disadvantages of an electronic device used everyday Speaking: exchanging information about mobile phones

Unit	Topic	Vocabulary	Skills
8 pp. 23-27	Telecommunications and networks	Means of transmission Ground and air transmission Main network components Network topologies	Reading: ground and air transmission; network components Listening: network topologies Writing: an article about the uses of computer networks Speaking: exchanging opinions on the use of everyday means of communication
9 pp. 28-33	Computer technology	Computer components: hardware and software USB flash drives Types of computers Internet connections	Reading: computer components; types of computers; different types of Internet connections Listening: USB flash drives Writing: a summary of the origins of the Internet Speaking: describing the features of your own computer
10 pp. 34-37	Automation and robotics	Automation technologies Robot applications Sensors and transducers	Reading: advantages and disadvantages of automation; applications of automation technologies; types of sensors Listening: robot applications; the optical mouse Writing: describing automation technologies Speaking: discussing the impact of automation on your life
11 pp. 38-41	Technical assistance	Preventive and corrective maintenance Car components Auto maintenance	Reading: types of maintenance; car maintenance tasks Listening: a dialogue between a mechanic and his customer Writing: describing the features of different types of maintenance Speaking: comparing the results of a quiz about car maintenance
12 pp. 42-46	Health and safety at work	Health and safety regulations and objectives Safety signs and colours Safety equipment Fire safety plan	Reading: safety and welfare in the UK; safety sign categories and meanings; safety equipment Listening: safety rules and accident procedures; dialogues about safety equipment and how to prevent accidents Writing: describing health and safety regulations and objectives
p. 47	Appendix	Symbols, electrical units, conventional metric units	

1

Materials

A mechanical engineer uses different materials to build **machinery** or **tools**. A specific knowledge of materials is required, concerning qualities, properties, costs and general characteristics.

1 What are these objects made of? Match the words in the box with the pictures, then read the text.

steel gold wood plastic
glass ceramic



1 _____



2 _____



3 _____



4 _____



5 _____



6 _____

When a machine or a tool is made, the most suitable material must be chosen by considering its properties, which can be classified as mechanical, thermal, electrical and chemical. The main types of materials used in mechanical engineering are metals, polymer materials, ceramics and composite materials. The most commonly used materials are metals, which can be divided into ferrous and non-ferrous. They can be used in their pure form or mixed with other elements. In this second case we have an **alloy** and it is used to **improve** some properties of the metals. The most commonly used ferrous metals are iron and alloys which use iron. Because iron is soft and pasty it is not suitable to be used as a structural material, so a small amount of **carbon** is added to it to make **steel** alloy.

Non-ferrous metals contain little or no iron. The most common non-ferrous metals used in mechanics are **copper**, **zinc**, **tin** and **aluminium**. Some common non-ferrous alloys are **brass** (formed by mixing copper and zinc), **bronze** (formed by mixing copper and tin) and other aluminium alloys which are used in the aircraft industry. Other examples of materials used in mechanical engineering are **plastic** and **rubber**.

PVC or polyvinyl chloride is a type of plastic and is used to **insulate wires** and **cables**. Rubber is a polymer and its best property is elasticity, as it returns to its original size and shape after deformation. Ceramic materials are good insulators: hard, resistant and strong, but **brittle**. Composite materials are made up of two or more materials combined to improve their mechanical properties. **Concrete** is reinforced with steel and is used in building engineering.

2 Read the text again and match the words with their definitions.

- | | |
|---------------------|--|
| 1 alloy | a <input type="checkbox"/> a type of plastic used for insulation |
| 2 steel | b <input type="checkbox"/> a combination of different metals |
| 3 PVC | c <input type="checkbox"/> an alloy formed by mixing iron and carbon |
| 4 concrete | d <input type="checkbox"/> an alloy formed by mixing copper and zinc |
| 5 brass | e <input type="checkbox"/> metals containing iron |
| 6 ferrous materials | f <input type="checkbox"/> a composite material used to build houses |
| 7 ceramic | g <input type="checkbox"/> a metal not suitable as structural material |
| 8 iron | h <input type="checkbox"/> a good insulator but brittle |

3 Read the text again and answer the questions.

- | | |
|---|---|
| 1 What is the basic classification of metals? | 4 Which materials are good insulators? |
| 2 What are the characteristics of iron? | 5 Is steel an alloy? Which metal does it contain? |
| 3 Why are alloys created? | |

4  Listen and complete the definitions with the words in the box.

cooking coins alloy air copper wires steel
carbon gold ferrum expensive ductile

- Iron: Its Latin name is (1) *ferrum*. It is magnetic and has a silvery colour. In prehistoric times it was used to make ornaments and weapons. If exposed to the (2) _____, it **oxidises**.
- (3) _____: It is one of the most widely used metals by humans. In prehistoric times it was used to make cooking utensils, (4) _____ and ornamental objects. It is used in (5) _____ and cables.
- (6) _____: It is the most (7) _____ metal and is used to create precious jewellery. It is the most (8) _____ metal.
- (9) _____: It is an (10) _____ formed from iron and (11) _____. It can contain between 2.1% and 4% carbon. It is also used for (12) _____ utensils and pans.

5 Complete the following diagram.

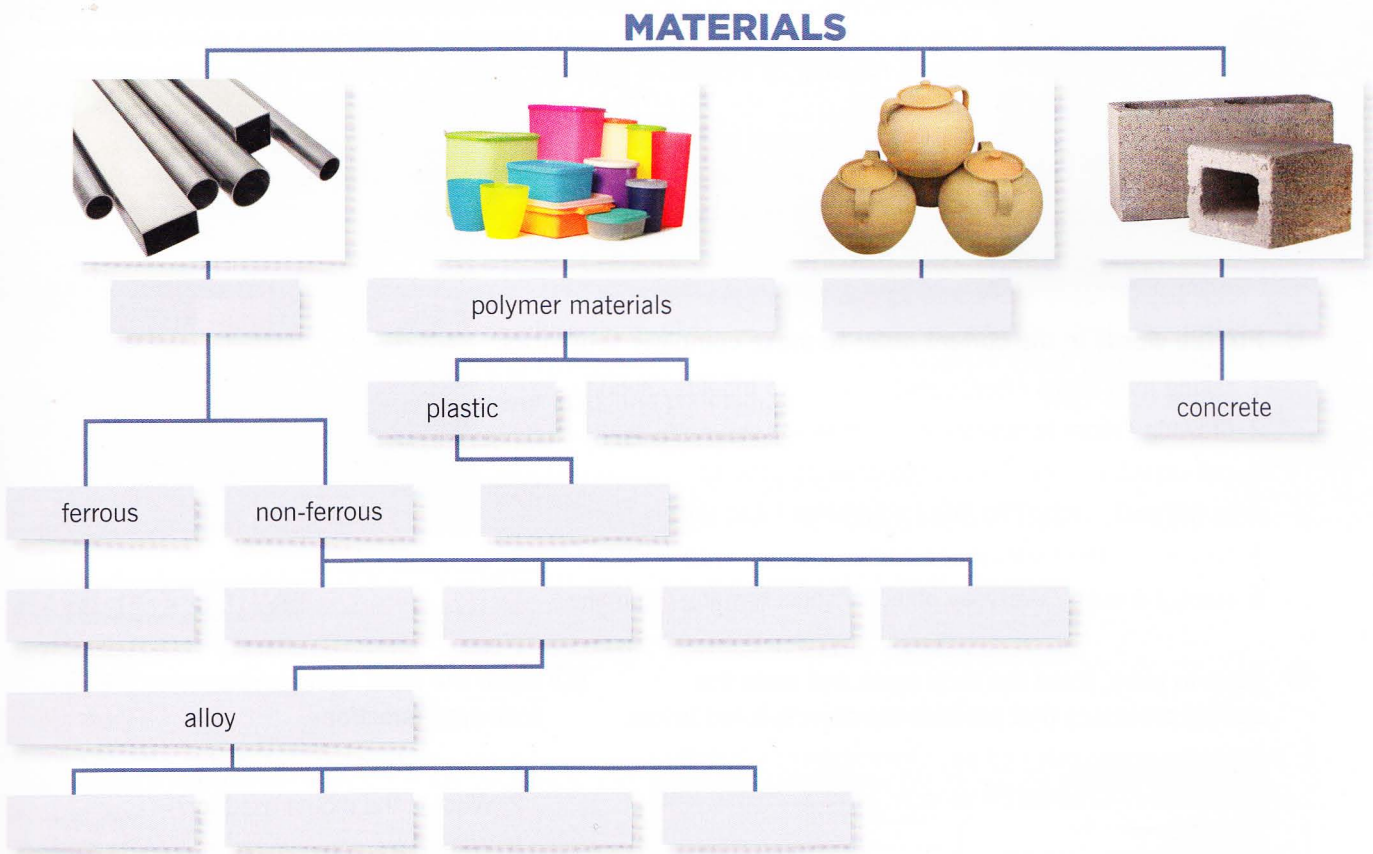

6 Write a summary of the texts in exercises 1 and 4 following the flow chart.

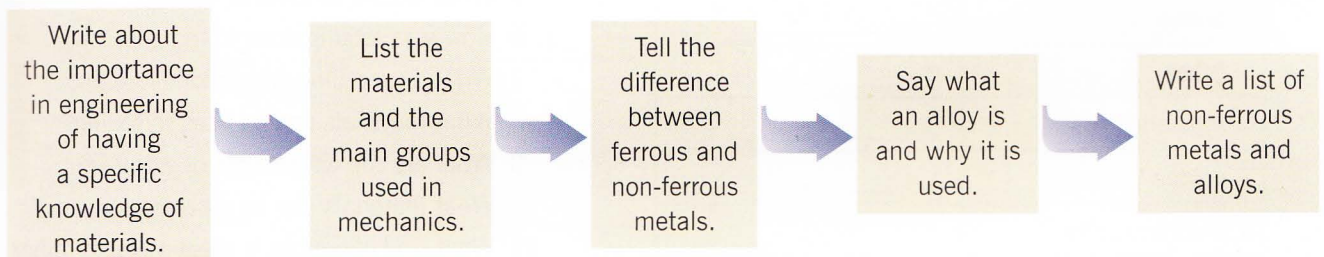

Metal processes

7  2 Listen and complete the texts about the different processes metals can go through.

Casting is a 6,000 year old process. It is the oldest and most well-known technique based on three fundamental steps: moulding, melting and (1) _____. First the pattern is made to form the **mould**. Then an empty mould is created, and finally the empty cavity is filled with molten metal which is then left to solidify into the shape. Casting materials are usually (2) _____ but can also be plastic, resin or various cold materials for example (3) _____. Casting is usually used for making complex shapes.

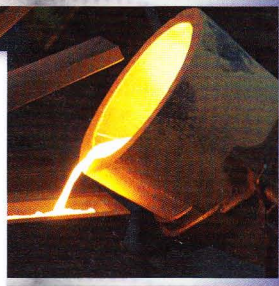

Drawing is a manufacturing process for producing wires, **bars** and (4) _____ by pulling on material through a series of **dies** until it increases in length. It is divided into two types: sheet metal drawing, and wire, (5) _____, and **tube** drawing. Drawing is usually done at room temperature but it can be performed at elevated temperatures to hot work large wires, **rods** or **hollow** sections in order to reduce forces.

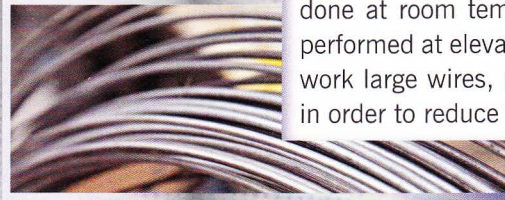

Forging is the process by which metal is heated and shaped by a compressive force using a **hammer** or a press. It is used to produce large quantities of identical parts, such as (6) _____ parts in the automobile industry. Cold forging is done at a low temperature using (7) _____ metals and plastic. Hot forging is done at a high temperature and makes metal easier to shape without breaking. In the past, forging was done by a **blacksmith** using a hammer. Nowadays industrial forging is done with (8) _____ powered by a machine.



8 Put the words in the correct order to make complete sentences.

- 1 taking their forms / fluid substances / into moulds / solidify _____
- 2 drawing / room temperature / is done at _____
- 3 not essential / heat / is / in the drawing process _____
- 4 in the past / using / forging / a hammer / was done _____
- 5 can be / brittle materials / extrusion / done / with _____
- 6 many / is used / everyday objects / sheet forming / to make _____

9 Work in pairs. Read the texts again and write the correct processes that produce the objects listed below.

Product	Process
1 wires	_____
2 pasta	_____
3 sheet	_____
4 bricks	_____
5 tubes	_____
6 rods and bars	_____
7 golden leaves	_____
8 machine parts	_____
9 concrete	_____

10 Read the texts again and answer the following questions.

- 1 Which steps are included in casting?
- 2 What is the mould used for?
- 3 What does drawing use in order to process metals?
- 4 What types of drawing are there?
- 5 What kind of process is forging?
- 6 How was forging done in the past?
- 7 What does rolling consist of?
- 8 What materials can be used in rolling?
- 9 What are the advantages of extrusion?
- 10 What materials can be used in extrusion?
- 11 What kind of process is sheet metal forming?
- 12 What can vary in sheet metal forming?



Rolling is a metal forming (9) _____ in which a material (metal, plastic, paper or glass) is passed through a pair of rollers. According to the (10) _____ of material rolled, there is hot rolling or cold rolling.



Extrusion is a process used to produce objects with a fixed cross-sectional profile. A material is pushed or drawn through a die of the desired cross-section. The two main (11) _____ of this process are its ability to create very complex cross-sections and work materials that are brittle. The extrusion process can be done with hot or cold materials. Commonly extruded materials include metals, polymers, (12) _____, concrete and foodstuffs.

Ceramic can also be formed into shapes via extrusion. Terracotta extrusion is used to produce **pipes**. Many modern **bricks** are also manufactured using a brick extrusion process. Extrusion is also used in (13) _____ processing. Products such as certain pastas, many breakfast cereals, French fries, dry pet food and ready-to-eat snacks are mostly manufactured by extrusion.

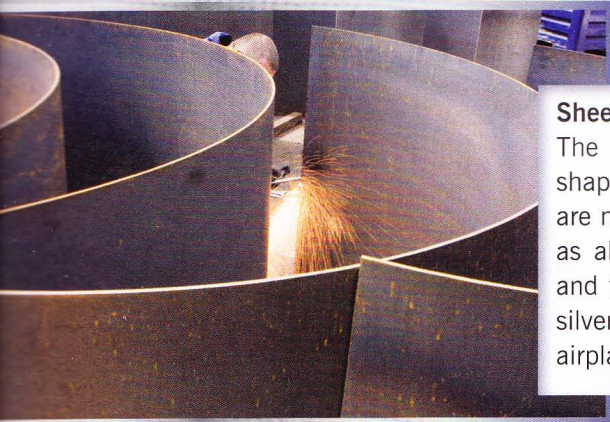
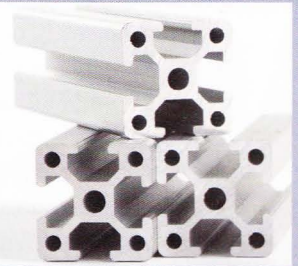

Sheet metal forming is simply metal formed into thin and **flat** pieces. The basic forms can be cut and **bent** into a variety of different shapes. Everyday objects are constructed with this process. There are many different metals that can be made into sheet metal, such as aluminium, (14) _____, copper, steel, tin, nickel and titanium. For decorative uses, important sheet metals include silver, gold, and platinum. Sheet metal forming is used in car bodies, airplane wings and roofs for (15) _____.

MY GLOSSARY

alloy /æləʊ/ _____
 aluminium /æljʊ'mɪniəm/ _____
 bar /bɑ:(r)/ _____
 bent /bent/ _____
 blacksmith /blæksmɪθ/ _____
 brass /brɑ:s/ _____
 brick /brɪk/ _____
 brittle /brɪtl/ _____
 bronze /brɒnz/ _____
 cable /keɪbl/ _____
 carbon /kɑ:bn/ _____
 casting /kɑ:stɪŋ/ _____
 concrete /kɒŋkri:t/ _____
 copper /kɒpə(r)/ _____
 die /daɪ/ _____
 drawing /drɔ:ɪŋ/ _____
 extrusion /ɪk'stru:ʒn/ _____
 flat /flæt/ _____
 hammer /hæmə(r)/ _____

hollow /hɒləʊ/ _____
 to improve /tu: ɪm'pru:v/ _____
 to insulate /tu: ɪn'sjuleɪt/ _____
 machinery /mæ'ʃɪnəri/ _____
 mould /məʊld/ _____
 to oxidise /tu: ɒksɪdaɪz/ _____
 pipe /paɪp/ _____
 plastic /plæstɪk/ _____
 rod /rɒd/ _____
 rolling /rɒlɪŋ/ _____
 rubber /rʌbə(r)/ _____
 shape /ʃeɪp/ _____
 sheet /ʃi:t/ _____
 steel /sti:l/ _____
 tin /tɪn/ _____
 tool /tu:l/ _____
 tube /tju:b/ _____
 wire /waɪə(r)/ _____
 zinc /zɪŋk/ _____

2

Technical drawing

1 Read the text about technical drawing and label the pictures.

Technical drawing, also known as **drafting**, is the act and discipline of composing plans. The main purpose of technical drawing is to describe or explain all the characteristics of a product, giving all the necessary information that will help a manufacturer to produce that component. The visual image should be accurate in terms of dimensions and proportions, and should provide an overall impression of what an object is or does. It is a precise task requiring a high level of **skill** and suitable engineering tools. A **drafter** is the person who makes a drawing and who requires a wide knowledge of geometry, trigonometry and spatial comprehension, and in all cases must be precise and accurate and give great attention to detail.

People who communicate with technical drawings use a visual language and technical standards that define practical symbols, perspectives and units of measurement. What are the tools and instruments used by a drafter in manual drafting? A **T-square**, a **protractor**, a **compass**, **rulers**, and **triangles**. Paper is also important and can be divided into layout paper, which is thin and fragile, and cartridge paper, which is heavier and more suitable for final drawings. Pencils used in drawing are graded from H to F depending on the **hardness**. The final drawing is made using a technical pen, graded according to the **point**, which must maintain the same line **width**. They are used with a range of stencils to add symbols, letters and patterns to the drawing. Rubbers remove pencils or pen writing when mistakes are found. Correction fluid is used to mask text errors.



1

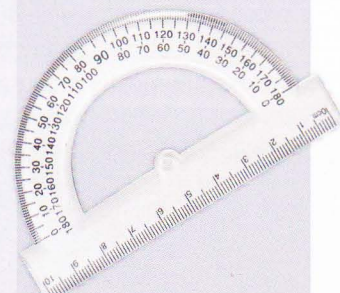

2



5



4

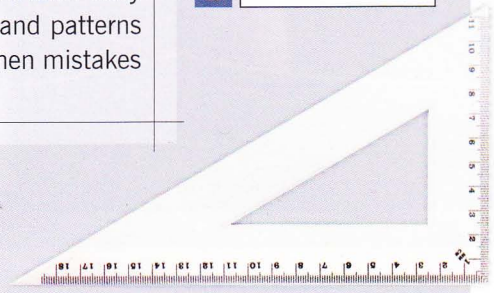

3

6

2 Read the text again and choose the correct answer.

- 1 Technical drawing is needed to...
 - A make a scale of the product.
 - B practise pens, rulers and stencils.
 - C let the manufacturer understand the requirements.
- 2 The drafter needs...
 - A some paper and a pencil.
 - B a wide range of technical instruments.
 - C the final product.
- 3 Paper is chosen considering...
 - A what sort of drawing the drafter is going to make.
 - B the pencils he/she is going to use.
 - C the drafter's preference.
- 4 Pencils are graded according to...
 - A hardness.
 - B hardness and colour.
 - C hardness and point.
- 5 A technical pen...
 - A makes regular lines.
 - B maintains the same line width.
 - C draws lines of the same length.
- 6 When mistakes are found...
 - A we can't correct them.
 - B they're removed with correction fluid.
 - C stencil can cover them.

3 Listen and complete the text with the words in the box.

creation advantages boards drawings software defects faster
instructions traditional reduce modification electronically

CAD/CAM systems

Drawing (1) _____ and manual drawing are not always precise and rapid: (2) _____ design is usually slow, especially in its revision and (3) _____. For this reason manufacturing firms have **replaced** manual drawing with computer-aided design (CAD) to **carry out** functions related to design and production. This computer technology assists the designer in the (4) _____, modification and analysis of a physical object. Nowadays computer (5) _____ can easily provide a three-dimensional drawing, which allows engineering designers to see how mechanical components may **fit** together without making models thus **saving** a lot of time. CAD is much (6) _____ and more accurate than manual drawing; designs can be quickly modified, reproduced and transmitted (7) _____. Computer simulated analysis of the model helps experts find problems and (8) _____ without building prototypes, in this way saving a lot of money and time. When the design is ready, the CAD system can generate the detailed (9) _____ needed to start product manufacturing. When CAD systems are linked to manufacturing equipment controlled by computers, they form an integrated CAD/CAM system. Computer-aided manufacturing (CAM) offers significant (10) _____ over traditional approaches by controlling manufacturing equipment with computers instead of human labour. CAM converts the design of a component into computer language and it gives (11) _____ to the computer regarding machine operations. Thanks to CAD/CAM systems it is possible to eliminate operator errors and (12) _____ manufacturing costs.

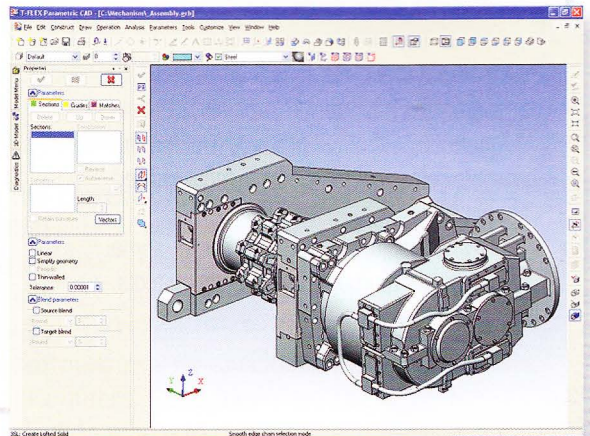

4 Read the text again and match each sentence with its ending.

- | | |
|---------------------------------------|---|
| 1 CAD helps designers | a <input type="checkbox"/> seen from any angle and are easily manipulated. |
| 2 By using a CAD technology | b <input type="checkbox"/> to draw, modify and correct designs. |
| 3 Unlike manual drawing, CAD | c <input type="checkbox"/> the design into computer language. |
| 4 CAD allows us to save | d <input type="checkbox"/> defects can be easily found. |
| 5 CAD designs can be | e <input type="checkbox"/> provides three-dimensional drawings. |
| 6 CAM is the use of computer software | f <input type="checkbox"/> time and money. |
| 7 The CAM system turns | g <input type="checkbox"/> minimise errors and manufacturing costs. |
| 8 CAD/CAM systems | h <input type="checkbox"/> to control machine tools in the manufacturing process. |

MY GLOSSARY

to carry out /tə 'kæri aʊt/ _____
 drafter /drɑ:ftə(r)/ _____
 drafting /drɑ:ftɪŋ/ _____
 to fit /tə fit/ _____
 hardness /hɑ:dnes/ _____
 point /pɔɪnt/ _____
 prototype /prəʊtətaɪp/ _____
 protractor /prə'træktə(r)/ _____

to replace /tə rɪpleɪs/ _____
 ruler /'ru:lə(r)/ _____
 skill /skɪl/ _____
 technical drawing /'teknɪkl 'drɔ:ɪŋ/ _____
 to save /tə seɪv/ _____
 triangle /traɪæŋɡl/ _____
 T-square /tɪ:skweə(r)/ _____
 width /wɪðθ/ _____

3

Machine tools

A **machine tool** uses a power source to modify the shape of metal components of machines. It is a sort of machine used as a tool in the making of other machines. Machine tools were powered in the Middle Ages by humans and animals, and later by the energy captured by **waterwheels**. After the Industrial Revolution, most machine tools were powered by **steam engine** and nowadays by electricity. Machine tools can be operated manually, or under automatic control. In the 1960s, computers gave more flexibility to the process. Such machines became known as computerized numerical control (CNC) machines. They could precisely repeat sequences, and could produce much more complex pieces than even the most **skilled** tool operators.

Let's examine the main **features** of some of the most commonly used machine tools.

Turning machine

The engine **lathe** is the most important of all the machine tools. It is used to produce external or internal cylindrical surfaces. The piece is held by the machine and is rotated while a cutting tool removes excess metal from the external diameter. Internal turning consists of enlarging and finishing a **hole**.

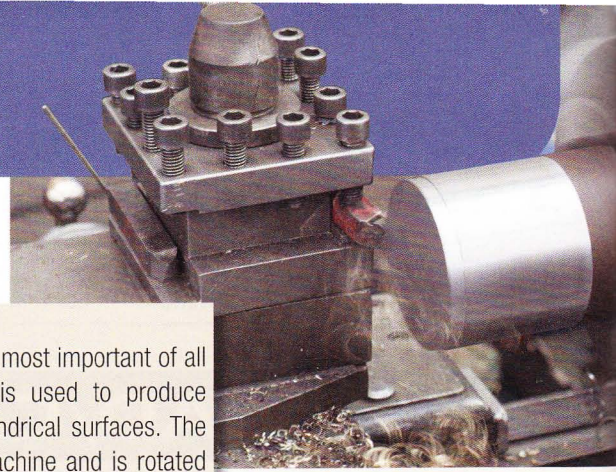

Shaper

This is a metal-cutting machine used to produce or modify flat surfaces. The cutting tool moves cutting on the forward **stroke**, with the piece feeding automatically towards the tool during each return stroke. Shapers can be horizontal or vertical.



Drilling machine

It is used to produce circular holes in metal with a twist drill. It also uses a variety of other cutting tools to perform the basic hole-machining operations.



1 Read the texts about metalworking processes and complete the table.

Machine tool	Final result	Description
<i>turning machine</i>	external and internal flat surface	It removes excess metal from the external diameter. It enlarges and finishes a hole.
	specific shape	It cuts flat metal surfaces.
	holes	It uses a twist drill to make holes.
	flat surface	It cuts the piece.
	specific shape	It changes the shape of a workpiece.
	cut pieces	It cuts various parts using a continuous band of metal with teeth.
	finishing	It removes excessive material from parts.

2 Read the texts again and decide if the following sentences are true (T) or false (F).

- Turning machines remove excess metal from the external diameter and enlarge and finish a hole. _____
- Shapers can only be vertical. _____
- Drilling machines use a twist drill to make circular holes. _____
- Milling machines can only be manually operated. _____
- Grinding machines remove excessive material from parts. _____
- Band saws use a band of metal with teeth to cut various parts. _____
- Presses are not dangerous if operated by both hands. _____

Milling machine

This cuts flat metal surfaces. The piece is fed against a rotating cutting tool. Cutters of many shapes and sizes are available for a wide variety of milling operations. Milling machines may be manually operated, mechanically automated, or digitally automated via computer numerical control (CNC).

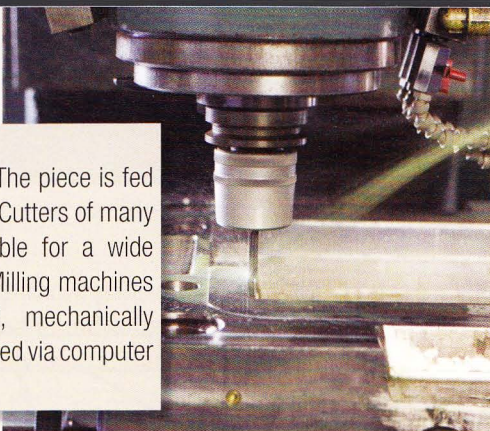

Grinding machine

This removes excessive material from parts that are brought into contact with a rotating abrasive wheel. Grinding is the most accurate of all the basic machining processes, but also the most time consuming.

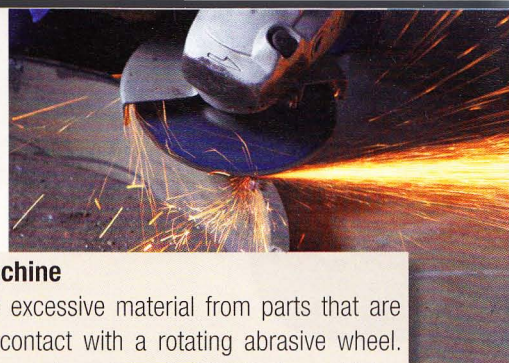

Press

This is a machine tool that changes the shape of a workpiece. Historically, metal was shaped by hand using a hammer. Machine presses can be dangerous. Bi-manual controls (controls which require both hands to be on the buttons to operate) are a very good way to prevent accidents.

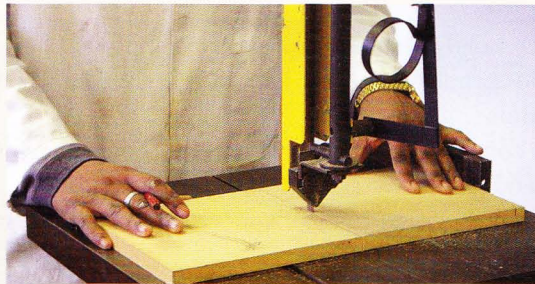

Band saw

It is a power tool which uses a **blade** consisting of a continuous band of metal with teeth along one edge. The band usually rides on two wheels rotating in the same plane. Band saws are used for woodworking, metalworking, or for cutting a variety of other materials, and are particularly useful for cutting irregular or curved shapes. A constant flow of liquid is poured over the blade to keep it **cool** and preventing it from **overheating**.

3 4 Read the text about CNC and put the sentences in the correct order.

Computer Numerical control (CNC) refers to the automation of machine tools in manufacturing processes. The machines are controlled by computer software which carries out a series of operations automatically. The first NC machines were built in the 1940s and 1950s. They are used to cut and shape products, such as automobile parts that need precise specifications. Parts must be carefully **planned** and prepared by CNC **programmers**. First they view the three-dimensional computer aided designed part. Then they calculate where to cut, the speed and shape and select the tools and materials. The CNC programmers translate the planned machine operations into a set of instructions. These instructions are translated into a computer aided manufacturing (CAM) program containing a set of commands for the machine. The commands are a series of numbers which explains where to cut and the position of material. The computer checks all the operations made by the machine tools.

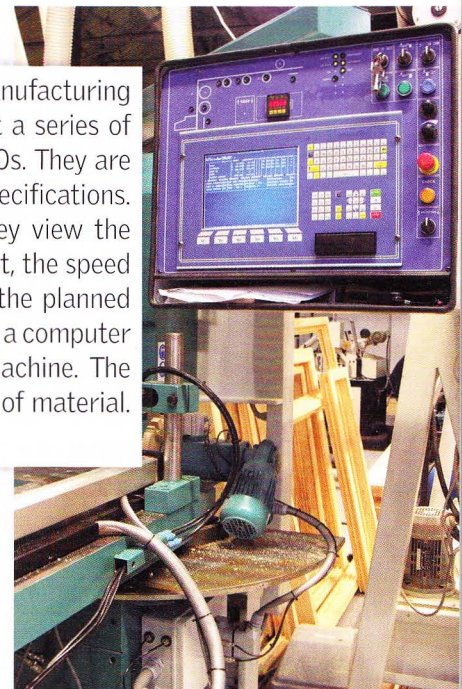

- a The planned machine operations are translated into a set of instructions.
- b These instructions are translated into a CAM program.
- c The program contains a set of commands for the machine.
- d It is calculated where to cut and tools and materials are selected.
- e The computer checks all the operations made by the machine tools.
- f Programmers view the part in its three-dimensional computer aided design.

MY GLOSSARY

band saw /bænd sə:/ _____
 blade /bleɪd/ _____
 cool /ku:l/ _____
 drilling machine /drɪlɪŋ mə'ʃi:n/ _____
 feature /fi:tʃə(r)/ _____
 grinding machine /grɑ:ndɪŋ mə'ʃi:n/ _____
 hole /həʊl/ _____
 lathe /leɪð/ _____
 machine tool /mə'ʃi:n tu:l/ _____

overheating /əʊvə'hi:tɪŋ/ _____
 press /pres/ _____
 programmer /prəʊgræmə(r)/ _____
 shaper /ʃeɪpə(r)/ _____
 skilled /skɪld/ _____
 steam engine /sti:m 'endʒɪn/ _____
 stroke /strəʊk/ _____
 turning machine /tɜ:nɪŋ mə'ʃi:n/ _____
 waterwheel /wɔ:təwi:l/ _____

4

What is electricity?

1 Read the text and label the picture with the name of each part.

All substances, solids, liquids or gases, are composed of one or more of the chemical elements. Each element is composed of identical atoms.

Each atom is composed of a small central nucleus consisting of protons and neutrons around which **orbit shells** of electrons. These electrons are very much smaller than protons and neutrons.

The electrons in the **outermost** shell are called **valence** electrons and the electrical **properties** of the substance depend on the number of these electrons.

Neutrons have no electric **charge**, but protons have a positive charge while electrons have a negative charge. In some substances, usually metals, the valence electrons are free to move from one atom to another and this is what constitutes an electric current.

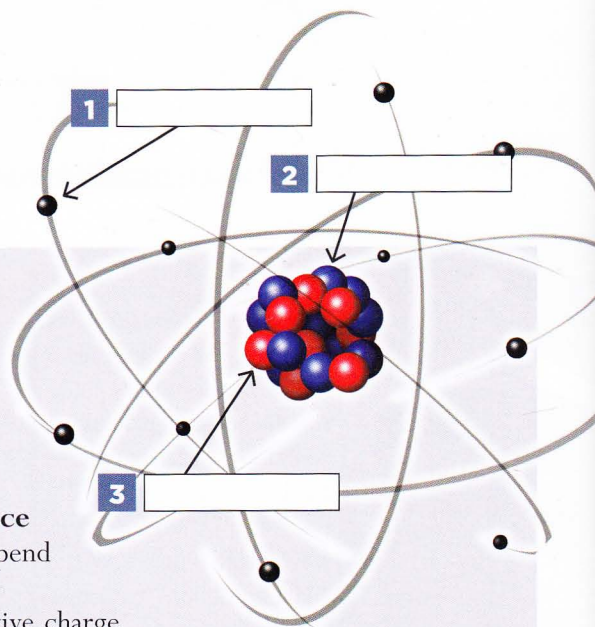

2 Read the text again and complete the sentences with the missing information.

- 1 Elements make up _____
- 2 Identical atoms _____
- 3 Atoms consist of _____, _____ and _____
- 4 Inside there are _____ and _____, while outside _____
- 5 Shells _____
- 6 Valence electrons _____
- 7 Neutrons do not have _____
- 8 Electricity is generated when _____

3 Listen and complete the text with the missing information.

Electricity consists of a (1) _____ of free electrons along a conductor. To produce this **current flow**, a generator is placed at the end of the conductor in order to move the (2) _____.

Conductors

Electricity needs a material which allows a current to **pass through** easily, which offers little (3) _____ to the flow and is full of free electrons. This material is called a conductor and can be in the form of a bar, tube or sheet. The most commonly used (4) _____ are wires, available in many sizes and **thicknesses**. They are **coated** with insulating materials such as plastic.

Semiconductors

Semiconductors such as silicon and germanium are used in transistors and their conductivity is **halfway** in between a conductor and an (5) _____. Small quantities of other substances, called **impurities**, are introduced in the material to (6) _____ the conductivity.

Insulators

A material which contains very (7) _____ electrons is called an insulator. Glass, rubber, dry wood and (8) _____ resist the flow of electric charge, and as such they are good insulating materials.

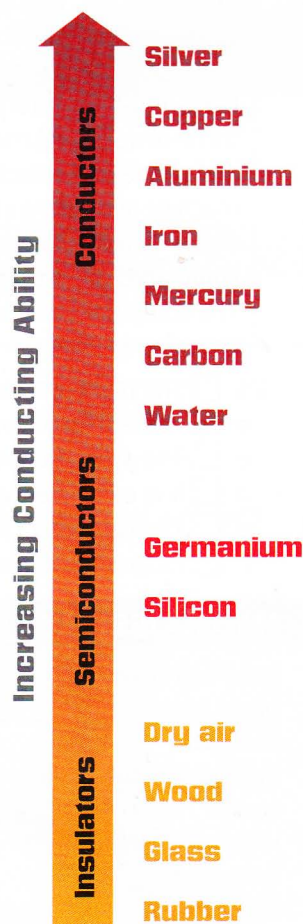

4 Read the text again and decide if the following statements are true (T) or false (F), then correct the false ones.

- 1 A flow of electrons moving inside a conductor creates an electric current. _____
- 2 A generator is used to move the charges. _____
- 3 Electrons can easily pass through any material. _____
- 4 Any material is a good conductor. _____
- 5 Conductors are coated with insulators. _____
- 6 The presence of free electrons affects the conductivity of materials. _____
- 7 Impurities are introduced to increase conductivity. _____
- 8 Insulating materials resist the flow of electrons. _____

5 Read the text and complete the table with the missing information.

There are two types of current: Direct current (DC) and Alternating current (AC).

Direct current is a continuous flow of electrons in one direction and it never changes its direction until the power is stopped or **switched off**.

Alternating current constantly changes its direction because of the way it is generated. The term 'frequency' is used to indicate how many times the current changes its direction in one second.

Alternating current has a great advantage over direct current because it can be transmitted over very long distances through small wires, by making energy high voltage and low current.

There are several quantities that are important when we are talking about electric current. Volts (V) – so **named**

after the Italian physicist Alessandro Volta – measure the difference of electric potential between two points on a conducting wire. Amperes (A) measure the amount of current flowing through a conductor, that is to say the number of electrons passing a point in a conductor in one second.

Coulomb (C) measure the quantity of charge transferred in one second by a **steady** current of one ampere. Power is the rate at which work is performed and it is measured in watts (W). A Kilowatt (kW), which is equal to one thousand watts, is used to measure the amount of used or available energy. The amount of electrical energy consumed in one hour at the constant rate of one kilowatt is called kilowatt-hour.

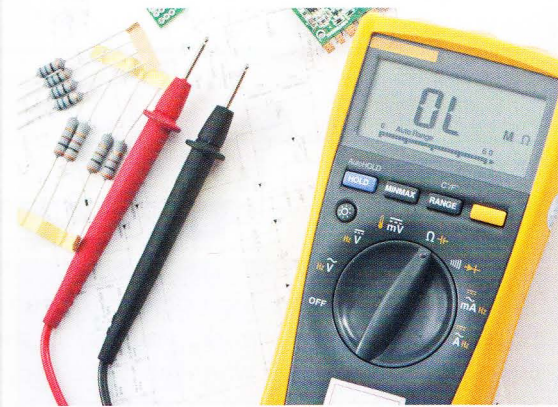

Unit of measurement	What does it measure?
(1) _____	the number of electrons passing a given point in a conductor in one second
(2) _____	the quantity of electricity transferred by a steady current of one ampere
(3) _____	the amount of electric energy used
(4) _____	the difference of potential between two points on a conductor
(5) _____	rate at which work is done

MY GLOSSARY

charge /tʃɑ:dʒ/ _____
 coated /kəʊtɪd/ _____
 conductor /kən'dʌktə(r)/ _____
 current flow /kʌrɪnt fləʊ/ _____
 halfway /hɑ:fweɪ/ _____
 impurity /ɪm'pjʊərɪti/ _____
 insulator /ɪnsjʊleɪtə(r)/ _____
 to name after /tə neɪm 'ɑ:ftə(r)/ _____
 to orbit /tu: 'ɔ:brɪt/ _____

to pass through /tə pɑ:s θru:/ _____
 property /prəpəti/ _____
 semiconductor /semikən'dʌktə(r)/ _____
 shell /ʃel/ _____
 steady /'stedɪ/ _____
 to switch off /tə swɪtʃ ɒf/ _____
 thickness /'θɪknəs/ _____
 valence /'væləns/ _____

5

Electric circuits

1 Read the text and label the picture with the name of each part.

An electric circuit or network is a pathway through which the electric current can flow. A simple circuit consists of a **power source**, two conducting wires, each one attached to a terminal of the source and a **device** through which electricity can flow. This device is called a **load** and it's attached to the wires. If all the parts are properly connected, the current flows and the lamp lights up. This kind of circuit is called 'closed'.

On the contrary, if the wires are disconnected the circuit is called 'open' or 'broken'. The circuit can be opened and closed by a device called a **switch**.

Loads can **turn** electrical energy **into** a more useful form. Some examples are:

- **light bulbs**, which change electrical energy into light energy;
- **electric motors**, which change electrical energy into mechanical energy;
- **speakers**, which change energy into sound.

The source provides the electrical energy used by the load. It can be a storage battery or a generator. The switch interrupts the current delivered to the load by the source and allows us to control the flow.

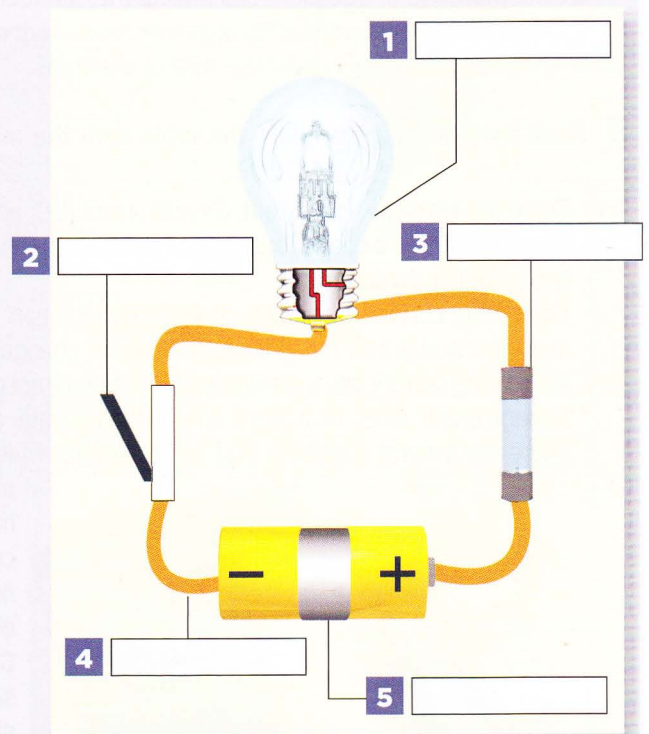

When an abnormally high amount of current passes through a network, you get a **short circuit**. This may occur when there is a drop in the **resistance** or a broken insulation. In order to **prevent** short circuits, it is best to use **fuses**, which **melt** when too much current flows through them, interrupting in this way the circuit.

2 Match the words with their definitions.

- | | |
|------------------|--|
| 1 load | a <input type="checkbox"/> a device which interrupts the circuit |
| 2 switch | b <input type="checkbox"/> a circuit in which wires are disconnected |
| 3 source | c <input type="checkbox"/> a device which provides power |
| 4 fuse | d <input type="checkbox"/> a complete circuit with no breaks at all |
| 5 closed circuit | e <input type="checkbox"/> a device which consumes electric power |
| 6 broken circuit | f <input type="checkbox"/> a protective device |

3 Read the text again and answer the following questions.

- | | |
|---|--|
| 1 What does a simple circuit consist of? | 5 What is the function of a switch? |
| 2 What happens to the lamp in a closed circuit? | 6 When does a short circuit occur? |
| 3 Can you name some examples of loads? | 7 What can we use to prevent short circuits? |
| 4 What is a generator? | 8 How does a fuse work? |

4 Complete the texts with the words in the box. Then listen and check.

components current turn on branch amount
positive appliances continue burns out path

The (1) *components* of a circuit can be wired in two different ways: series or parallel. If components are **arranged** one after another to form a single (2) _____ between the terminals and the components, the circuit is known as a **series circuit**. In this type of circuit, the (3) _____ flows from the negative terminal to the (4) _____ terminal, passing through all the other components of the circuit. This means that the (5) _____ of energy passing through all the components in the series is the same. The main disadvantage of a series circuit is that when a single component in the path (6) _____, the entire circuit stops operating (e.g. Christmas tree lights).

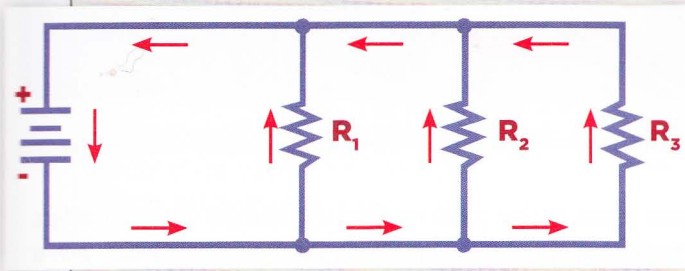
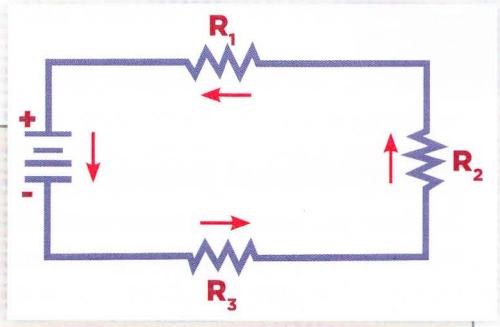

A **parallel circuit** consists of several paths connecting the different components. Each separate path is called a (7) _____ of the circuit. Current from the source divides and flows through the different **branches**. Unlike series circuits, if one of the components in the parallel circuit **burns out**, the other paths (8) _____ to operate. Parallel circuits are commonly used to connect (9) _____ at home, so that each **socket** can function independently. For example, you don't have to (10) _____ the light in your room for the TV socket to work.

5 Read the text and find synonyms for the words below.

A fuse can be added to an electric circuit to protect it from the effects of **undue** power. This safety device, which is made of a heat-sensitive alloy, is connected in series with the circuit it has to protect. If an excessive amount of current flows through the circuit, the alloy will liquefy and open the circuit. A circuit breaker is fundamental in a house to protect circuits against overloading, overheating and short circuits. The advantage of a circuit breaker is that it can be reset after the overloading by replacing the fuse. A professional electrician should always provide his customers with a map of the electric circuit in the house so that it will be easier to work on it in case of **faults**.



- 1 excessive: _____
- 2 reacting to high temperatures: _____
- 3 to melt: _____
- 4 loading up: _____
- 5 adjusted: _____
- 6 clients: _____

MY GLOSSARY

to arrange /tu: ə'reɪndʒ/ _____
 branch /brɑ:ntʃ/ _____
 to burn out /tə bɜ:n aʊt/ _____
 device /dɪ'vaɪs/ _____
 fault /fɔlt/ _____
 fuse /fju:z/ _____
 light bulb /laɪt bʌlb/ _____
 load /ləʊd/ _____
 to melt /tə melt/ _____
 parallel circuit /pə'ræləl 'sɜ:kɪt/ _____

power source /paʊə(r) sɔ:s/ _____
 to prevent /tə prɪ'vent/ _____
 series circuit /'sɪəri:z 'sɜ:kɪt/ _____
 short circuit /ʃɔ:t 'sɜ:kɪt _____
 socket /sɒkɪt/ _____
 speaker /spi:kə(r)/ _____
 switch /swɪtʃ/ _____
 to turn into /tə tɜ:n 'ɪntu:/ _____
 undue /ʌn'dju:/ _____

6

How energy is produced

Conventional power plants

1 Have you ever wondered where the electricity in your house comes from? Read the texts about the different types of power plants and match them with the pictures.

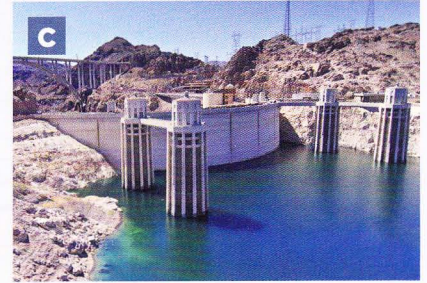

1 Nuclear power plants

About 10% of the world's electric power is produced by nuclear power plants. Nuclear power **requires** little **fuel** and causes much less air **pollution** than other power plants, but it can cause severe health and environmental problems when accidents **occur**, with a consequent release of radioactive material. This type of energy is produced by the **splitting** of atoms of uranium, which **releases** heat. This process – called fission – produces large amounts of **steam**, which is used to turn the **blades of turbines** thus creating energy. The main problems with nuclear power are linked to the location of the power plants, as people are not **willing** to have these plants near their homes, and the disposal of **waste** material, which stays radioactive for centuries.

2 Thermoelectric power plants

They provide about $\frac{2}{3}$ of the world's electricity. These plants burn fossil fuels, such as coal, oil or natural gas, which are all non-**renewable** resources. This means that in the future there will be a limited **supply** of these resources. The main advantage of thermoelectric power plants is that they are **reliable** and can meet the demand in peak periods. Electricity is generated by heating water in a **boiler** to create steam, which is then pressurised and used to turn the blades of giant turbines that produce electricity. These power plants cause environmental pollution because of the combustion of fossil fuels which release carbon dioxide.

3 Hydroelectric power plants

The energy produced by water can be captured and turned into electricity. The use of a **dam** on a river allows hydroelectric power plants to store water in an artificial lake, or reservoir. When released, the force of the water spins the blades of giant turbines, which are connected to a generator producing energy. Hydropower is one of the most important renewable energy resources, because it is reliable, efficient and does not pollute the air. Although it has high initial costs, it is cheap to operate. Unfortunately, it has a great impact on the **environment**, as humans, animals and plants may lose their natural habitats.

2 Read the texts again and decide if the following sentences are true (T) or false (F), then correct the false ones.

- 1 Nuclear power plants do not produce air pollution at all. _____
- 2 Accidents in nuclear power plants can have terrible consequences for the environment. _____
- 3 Nuclear power plants produce biodegradable waste material. _____
- 4 Thermoelectric power is generated by the combustion of renewable resources. _____
- 5 Thermoelectric power plants are environmentally friendly. _____
- 6 Dams are built on rivers to store water. _____
- 7 The water released from the reservoir flows through the generator. _____
- 8 The only disadvantage of hydropower is its high initial cost. _____

Alternative power sources

3 Read the texts about alternative power sources and complete the table with the missing information.

Environmental problems such as the **greenhouse effect** and air pollution have led scientists to find alternative power sources which are renewable and less polluting.

SOLAR ENERGY

Sunlight can be directly converted into electricity by solar cells made of silicon. When light strikes the cells, a part of it is absorbed by the semiconductor material. The energy of the absorbed light **knocks** electrons loose, allowing them to flow freely and produce electricity. The process of converting light (photons) into electricity (voltage) is known as the photo-voltaic process (PV). Solar cells are usually combined into panels and grouped into **arrays**. Even if the initial costs can be high, the PV system provides an independent, reliable electrical power source. It can produce energy for more than 15 years and its routine **maintenance** is simple and cheap.

WIND ENERGY

Wind energy is one of the cheapest renewable technologies available today. The wind turns the blades of giant turbines, producing in this way kinetic energy which is then converted into mechanical power and electricity by a generator. The main disadvantage of wind energy is that there are few suitable wind sites where it is possible to have a constant production of electricity.

TIDAL ENERGY

This alternative power source, which is typically used in coastal areas, turns the potential energy of **tides** into electricity. Tidal power generators use rising and falling tides in much the same manner as hydroelectric

power plants. Large underwater turbines are placed in areas with high tidal movements and are designed to capture the kinetic energy of rising and falling tides. The turbines are driven by the power of the sea both when the tide comes in and when it goes out. The problem with tidal power is that only massive increases in tides can produce energy and there are very few places where this occurs. Moreover, the aquatic ecosystem and the **shoreline** can be **damaged** by the changes in the tidal flow.

GEOTHERMAL ENERGY

In the past, people used **hot springs** for bathing, cooking and heating. Geothermal energy is based on the fact that the Earth is hotter below the surface. The hot water which is stored in the Earth can be brought to the surface and used to drive turbines to produce electricity or it can be **pipied** through houses as heat. This energy is cheap and has a low impact on the environment, but there are few sites where it can be extracted at low cost.

BIOMASS ENERGY

Biomass is a renewable energy source deriving from plant material and animal waste. When it is burnt, it releases its chemical energy as heat. Biomass fuels include forest residues (such as dead trees, branches and tree **stumps**), **straw**, **manure** and even municipal solid waste. Biomass energy is a natural process, it is carbon neutral and has low initial costs. It used to be the main source of heating at home in the past and it continues to be highly exploited in the developing world. The main disadvantage of biomass is that it has a smaller potential than other energy sources and requires excellent maintenance skills.

Type of energy	How it works	Advantages	Disadvantages
			<i>high initial costs</i>
<i>Wind energy</i>			
		<i>It is a natural process because it exploits the potential energy of tides.</i>	

4 Match the words with their definitions.

- | | |
|---------------|--|
| 1 array | a <input type="checkbox"/> a spot where hot water comes up naturally from the ground |
| 2 kinetic | b <input type="checkbox"/> unwanted material left after using |
| 3 tide | c <input type="checkbox"/> a group of things arranged in a particular way |
| 4 hot spring | d <input type="checkbox"/> waste material from animals used as fertiliser |
| 5 to pipe | e <input type="checkbox"/> the process of keeping something in good condition by regularly checking it |
| 6 manure | f <input type="checkbox"/> produced by motion |
| 7 waste | g <input type="checkbox"/> to send a liquid or a gas through a tube |
| 8 maintenance | h <input type="checkbox"/> the regular change in the level of the sea caused by gravitational attraction of the moon and the sun |

5 7 Read the text about the electrical distribution system and complete it with the words in the box. Then listen and check.

pole demand lower voltages consumers high-voltage
power plants delivery appliances **network** transformer

Electricity distribution is the final stage in the (1) _____ of electricity to end users. In order to be able to use electric power for our daily activities, electricity must be transmitted from the (2) _____ to other areas where it can be distributed to different (3) _____. The electricity generated by power plants is increased or **stepped up** at substations and distributed through (4) _____ transmission lines, in order to minimize energy **losses** and to economise on the material needed for conductors. Transmission lines use voltages as high as 765,000 volts and they are usually connected in a (5) _____. This means that if a station receives an unexpected (6) _____ for electric power, it can call on the other stations to help to meet the demand. Then electrical power is converted from high voltage to (7) _____ thanks to step-down transformers which turn electricity into different power levels. Once it is sent to your neighbourhood, another small (8) _____ mounted on a (9) _____ converts the power to even lower levels to be used at home. The final voltage is between 110 volts – for lights, TVs, and other smaller appliances – and 240 volts for larger (10) _____.

6 Reorder the different stages in the distribution system and match them to the numbers in the picture.

- Transmission lines carry high-voltage electricity to different substations.
- Electricity leaves the power plant.
- Electricity is **stepped down** by transformers.
- Current at lower voltages is transmitted to homes and offices.
- The voltage is increased at a step-up station.
- Power levels are lowered by small transformers mounted on poles.

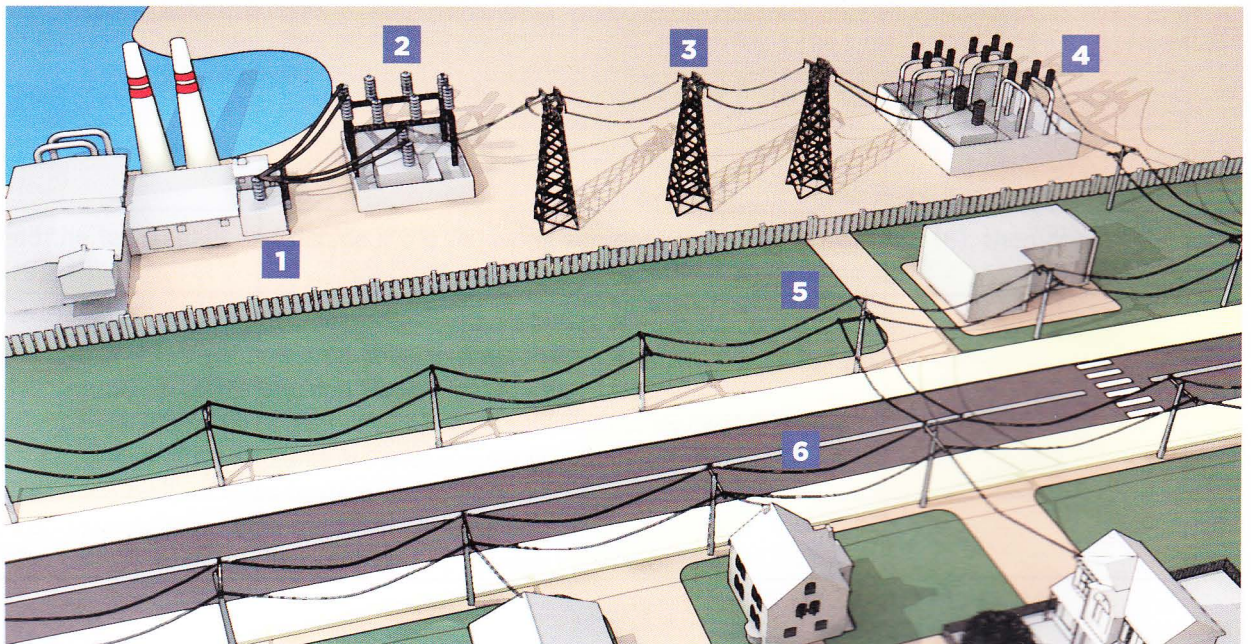

7 Read the text again and match each sentence with its ending.

- | | |
|------------------------------------|--|
| 1 Power plants generate | a <input type="checkbox"/> convert electricity from high voltage levels to lower levels. |
| 2 Transmission lines are used | b <input type="checkbox"/> in case of an expected demand for electric power. |
| 3 High voltages mean | c <input type="checkbox"/> a reduction in energy losses during transmission. |
| 4 Step-down transformers | d <input type="checkbox"/> power and distribute it to substations. |
| 5 Substations can help each other | e <input type="checkbox"/> can be safely used in businesses and homes. |
| 6 The current transmitted by poles | f <input type="checkbox"/> to distribute high-voltage electricity to a network of substations. |

8 What is your opinion on energy saving? What do you and your family usually do to save energy? Take this test and discuss your answers in pairs.

- | | |
|--|--|
| 1 I turn my desk lamp on only when it's dark. | Yes <input type="checkbox"/> No <input type="checkbox"/> |
| 2 I try to open the fridge as little as possible. | Yes <input type="checkbox"/> No <input type="checkbox"/> |
| 3 I don't use the lift to go down the stairs. | Yes <input type="checkbox"/> No <input type="checkbox"/> |
| 4 My parents take the bus to work instead of driving. | Yes <input type="checkbox"/> No <input type="checkbox"/> |
| 5 Our house temperature is below 20°C. | Yes <input type="checkbox"/> No <input type="checkbox"/> |
| 6 I always turn the light off when I leave a room. | Yes <input type="checkbox"/> No <input type="checkbox"/> |
| 7 I turn the TV off if I am not watching it. | Yes <input type="checkbox"/> No <input type="checkbox"/> |
| 8 We try not to use air conditioning unless it's very hot. | Yes <input type="checkbox"/> No <input type="checkbox"/> |
| 9 We use rechargeable batteries. | Yes <input type="checkbox"/> No <input type="checkbox"/> |
| 10 We use energy-saving light bulbs. | Yes <input type="checkbox"/> No <input type="checkbox"/> |

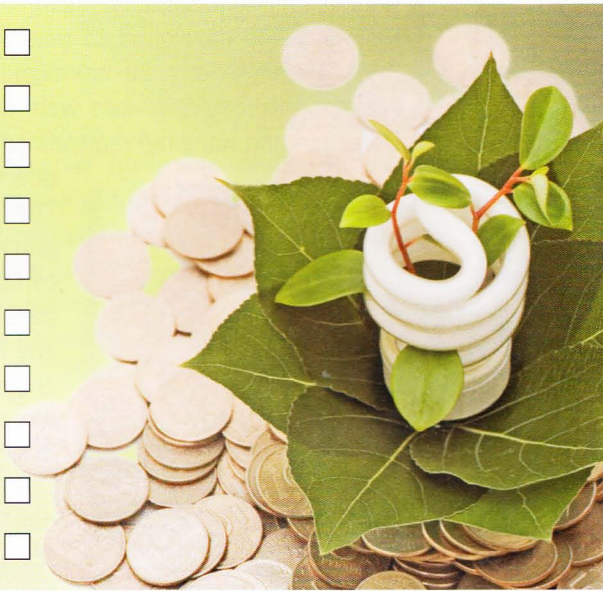

MY GLOSSARY

array /ə'reɪ/ _____
 biomass /'baɪəʊmæs/ _____
 blade /bleɪd/ _____
 boiler /'bɔɪlə(r)/ _____
 dam /dæm/ _____
 to damage /tə 'dæmɪdʒ/ _____
 environment /ɪn'vaɪərənmənt/ _____
 fuel /fjuəl/ _____
 greenhouse /'grɪnhaʊs/ _____
 hot spring /hɒt 'sprɪŋ/ _____
 to knock /tə nɒk/ _____
 loss /lɒs/ _____
 maintenance /'meɪntənənts/ _____
 manure /mə'njuə(r)/ _____
 network /'netwɜ:k/ _____
 to occur /tu: ə'kɜ:(r)/ _____
 piped /paɪpt/ _____
 pollution /pə'lju:ʃn/ _____

power plants /'paʊə(r) plɑ:nts/ _____
 to release /tə rɪ'li:s/ _____
 reliable /rɪ'laɪəbl/ _____
 renewable /rɪ'nju:əbl/ _____
 to require /tə rɪ'kwaɪə(r)/ _____
 shoreline /'ʃɔ:ləɪn/ _____
 splitting /'splɪtɪŋ/ _____
 steam /sti:m/ _____
 to step down /tə step daʊn/ _____
 to step up /tə step ʌp/ _____
 straw /strɔ:/ _____
 stump /stʌmp/ _____
 supply /sə'plaɪ/ _____
 tide /taɪd/ _____
 turbine /tɜ:'baɪn/ _____
 waste /weɪst/ _____
 willing /'wɪlɪŋ/ _____

7

What is electronics?



1 Read the text about the main inventions in electronics and complete the table with the missing information.

Electronics is the **branch** of science which controls electricity in order to **convey** a **signal** using semiconductor materials. These signals represent numbers, letters, sounds, pictures, computer instructions or other information. Radio systems were developed to read and understand these signals and in 1920 radio **broadcasting** started, making it possible for electromagnetic **waves** to travel long distances.

More sophisticated devices were needed during the Second World War and the invention of radar (Radio Detection and Ranging) represented a **further** step in electronics, making it possible to determine the altitude, direction and speed of moving and fixed objects.

The invention of television in the 1920s was one of the most revolutionary and popular inventions in history and it showed the importance of electronics in certain branches of industry. For the first time in history it became possible to transmit images and sound over wire circuits.

The first computer appeared in 1946. This machine, which could solve a wide range of computing problems, was built over a period of three years by a team of American scientists working at the University of Pennsylvania. It was a **huge** machine weighing almost 50 tons.

The first transistor was assembled in 1957 by a team of scientists working at the Bell Laboratories in the U.S.A, and it was a real coming of age in the science of electronics because it replaced the use of valves. Transistors are very

small, easy to handle, cheap, and they use little power.

The silicon chip – which followed the transistor in the 1960s – can contain up to several thousand transistors packed and interconnected in **layers** beneath the surface. It is really **tiny** (usually less than one centimetre square and about half a millimetre thick) and it has **paved the way** to microelectronics.

Electronics has influenced and improved the way information is stored, processed and distributed. Social and personal life has been deeply affected by these inventions and many financial, business, medical, education and political routines have been **speeded up**.

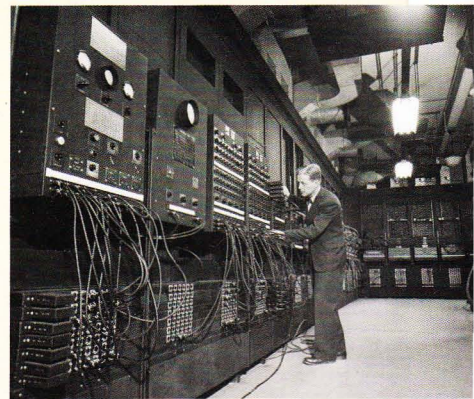

Invention	Year	Function
		<i>read and understand electronic signals</i>
Radar	1920s	

2 Think of an electronic device (TV, radio, mobile phone, computer, etc.) you use every day. Write about its use, advantages, disadvantages and your opinion of it. Write about 60 words.

Electronic circuits

3 Read the text about the different kinds of electronic circuits and answer the questions.

A conventional electronic circuit is made of separate components attached to a base called a printed circuit board (PCB). Before being finalised and manufactured, the electronic circuit must be tested many times on an experimentation board called a **breadboard**. It consists of a perforated block of plastic with several **spring clips** connected by copper wires. It doesn't require **soldering** as its components can be pushed straight into the holes, so it is easy to change connections and replace pieces. It is generally used to create temporary **prototypes** and experiment with circuit design.

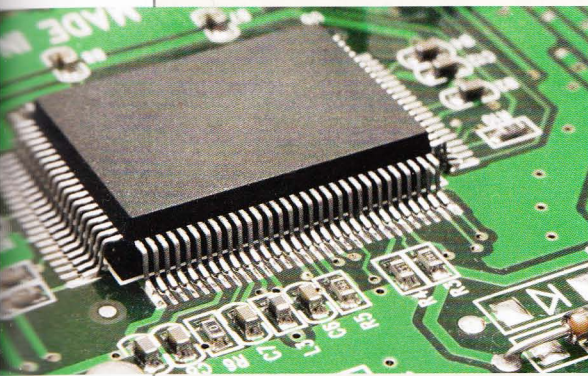
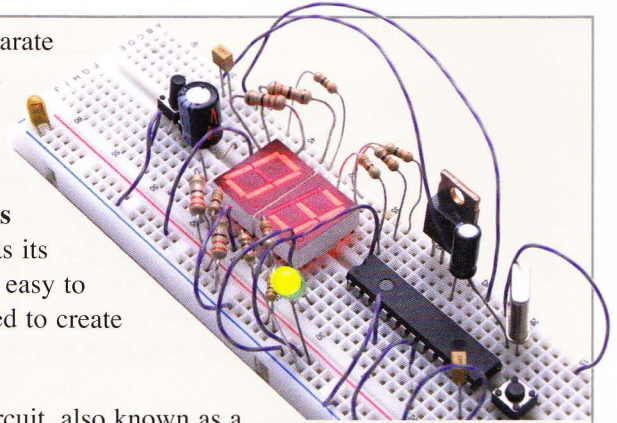

The integrated circuit, also known as a chip, is one of the most important inventions of the 20th century. Integrated circuits are used in almost all electronic equipment today, for example watches, calculators and microprocessors. It consists of millions of transistors and other electronic components combined to form a complex set on a thin **slice** of silicon or other semiconductor material. Chips are becoming tinier and tinier and they are produced in large quantities so that costs are reduced. Since signals have to travel a short distance, they work faster, consume less power and generate less heat. They are also more reliable given the limited amount of connections which could fail.

The microprocessor is the heart of any normal computer: it is a logic integrated circuit chip which can carry out a sequence of operations when it receives instructions from different input devices. As it doesn't contain a large memory, it can't work alone but needs to be supported by other integrated circuits to be connected with **peripherals**. Most microprocessors are found inside computers and are called the CPU (Central Processing Unit). In order to work properly, the microprocessor needs to receive instructions from a memory chip. These instructions are then **decoded**, executed and elaborated so as to get the results available. The most sophisticated microprocessors can contain up to 10 million transistors and run 300 million cycles per second. It means that the computer can perform about a billion instructions every second. As technology continues to evolve, microprocessors are becoming tinier and tinier.

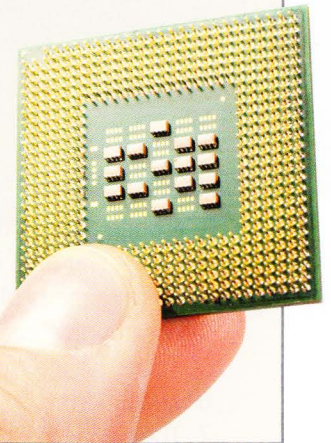

- 1 What is a conventional circuit made of?
- 2 What does PCB stand for?
- 3 What is a breadboard?
- 4 What does a chip consist of?
- 5 What is a chip made out of?
- 6 What are the advantages of chips compared to conventional electronic circuits?
- 7 What is a microprocessor?
- 8 How many instructions can computers perform?

4 Read the text again and match the words with their definitions.

- | | |
|--------------|--|
| 1 prototype | a <input type="checkbox"/> to convert an electrical signal into another code |
| 2 perforated | b <input type="checkbox"/> the act of joining metallic parts |
| 3 soldering | c <input type="checkbox"/> an original model used to test a circuit or a product |
| 4 to fail | d <input type="checkbox"/> to perform ineffectively |
| 5 peripheral | e <input type="checkbox"/> having a series of holes |
| 6 to decode | f <input type="checkbox"/> an auxiliary device that works with a computer |

5  **8** Read the text about mobile phones and complete it with the words in the box. Then listen and check.

cell lines microprocessor photos radio signals
flash emails antenna movement

A cellular phone (or mobile phone) is designed to give the user freedom of (1) _____ while using a telephone. It uses (2) _____ signals to communicate between the phone and the (3) _____. The server area is divided into smaller areas called cells and an antenna is placed within each cell and connected by telephone (4) _____. These lines connect cellular phones to one another: a computer selects the antenna closest to the telephone when a call is made. If the phone moves to one serving (5) _____ to another, the radio signal is transferred to the actual cell without interrupting the conversation.

The circuit board is the heart of the system. A chip translates the **outgoing** and **incoming** (6) _____ from analogue to digital and back from digital to analogue. The (7) _____ handles all the functions for the keyboard, the display and the loudspeakers, and it controls the signal to the base station.

Other (8) _____ memory chips provide storage for the **operating system**.

A cellular phone is not only a phone but it provides an incredible amount of functions:

- store information;
- use a calculator;
- send and receive (9) _____;
- surf the Internet;
- play simple games;
- play music, take (10) _____ and videos.

Can you imagine your life without your mobile phone?

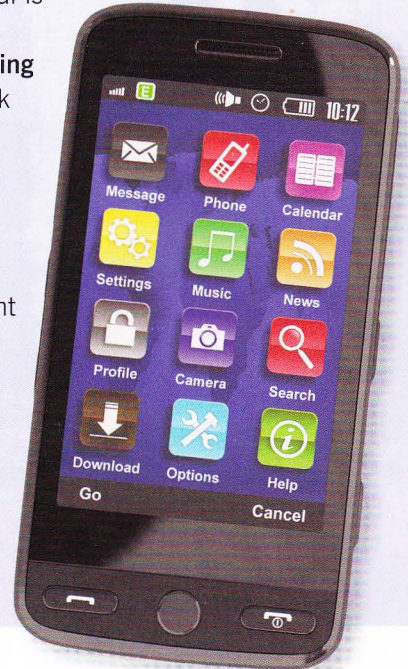

6 In pairs, decide if the following statements are true (T) or false (F).

- 1 Mobile phones use radio signals to communicate. _____
- 2 The server area is divided into smaller areas called stations. _____
- 3 An antenna is placed every two or three cells. _____
- 4 Communication with a mobile within a cell is independent from the base station. _____
- 5 There are interruptions when you move to one cell to another. _____
- 6 The antenna is the heart of the system. _____
- 7 The signal must be translated. _____
- 8 The flash memory handles all the functions. _____
- 9 Loudspeakers are controlled by the microprocessor. _____
- 10 You can text and send emails with your mobile phone. _____

MY GLOSSARY

branch /brɑ:ntʃ/ _____	outgoing /aʊt'gəʊɪŋ/ _____
breadboard /'bredbɔ:d/ _____	to pave the way /tə peɪv ðə weɪ/ _____
broadcasting /'brɔ:dkɑ:stɪŋ/ _____	peripheral /pə'rɪfərəl/ _____
to convey /tə kən'veɪ/ _____	signal /'sɪgnəl/ _____
to decode /tə di:'kəʊd/ _____	slice /slaɪs/ _____
further /'fɜ:ðə(r)/ _____	soldering /səʊldərɪŋ/ _____
huge /hju:dʒ/ _____	to speed up /tə spi:d ʌp/ _____
incoming /'ɪnkʌmɪŋ/ _____	spring clip /sprɪŋ klɪp/ _____
layer /leɪə(r)/ _____	tiny /tɪni/ _____
operating system /'ɒpəreɪtɪŋ 'sɪstəm/ _____	wave /weɪv/ _____

Telecommunications and networks

8

Communication has always played a crucial role in human societies and over time its forms have evolved through the progression of technology, transforming itself into telecommunication. The telegraph, the telephone, the radio, the television, the radar, the fax and, more recently, the computer are all devices which were invented to communicate using electromagnetic waves. Thanks to them, we can transmit texts, pictures, sounds and images and reach everyone in any part of the world.

1 Work in pairs. Look at the following means of communication and take turns asking and answering the following questions.

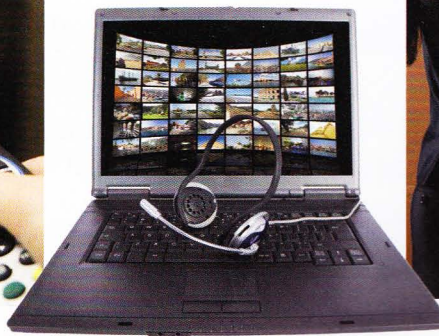

How often do you use them?
 What do you use them for?
 Who do you use them with?
 What are their advantages?
 Can you think of any risk connected with their use?

2 Look at the diagram and complete the text about telecommunication systems.

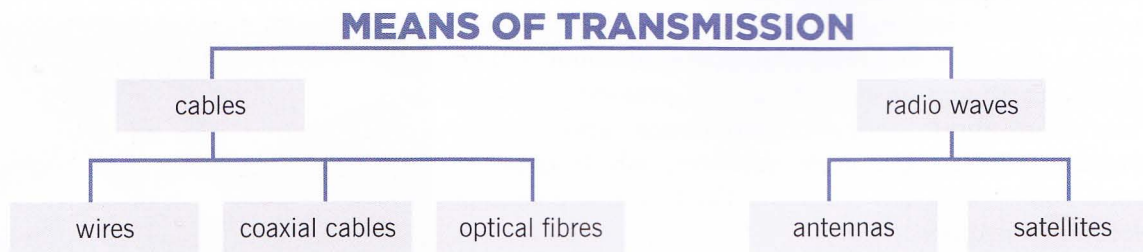

Telecommunication systems need means for the (1) _____ of any information, which is translated into electromagnetic waves that connect the **transmitter** to the **receiver**. These means can be physical media, such as (2) _____, or radio (3) _____, which are transmitted by air. Different kind of cables can be used. The simplest communication cables consist of a single pair of (4) _____ **twisted** together. Other types are (5) _____ cables and optical (6) _____. Radio waves need (7) _____ to be transmitted and sometimes (8) _____ are necessary for long-distance transmission.

3 Read the text about the different kinds of transmission media and complete the table.

Ground transmission

Wires provide a cheap and effective means of communication that was predominant in the past. Wires, which are made out of copper and insulated with plastic, can be single or twisted, and they are used mainly in telephone and computer networks.

Coaxial cables consist of an **inner** conductor insulated with plastic and **surrounded** by a **woven** copper **shield**. They are used in television and radio as these cables can support about 60 channels. The inner copper cable is insulated to protect the wires from **bending** and crushing and to reduce the noises.

Optical fibres are used in place of simple copper wires to carry larger amounts of information. They consist of **strands** of pure glass as thin as a human hair. Signals travel along fibres with less loss and without any electromagnetic interference. As they permit transmission over longer distances and at a higher speed, they are used in communication systems, in some medical instruments and in a wide variety of **sensing devices**.

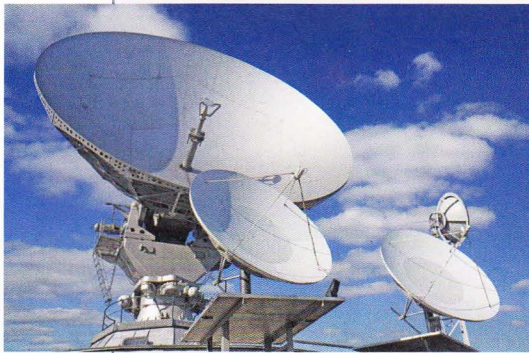
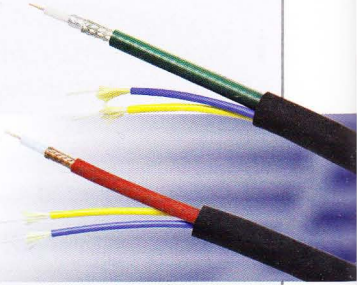

Air transmission

Antennas were invented to capture radio signals and convert them into electrical signals through the receiver. They can also receive electrical signals from the transmitter and convert them into radio signals.

These electric devices, which provide information at a cheap rate, are essential to all equipment that uses radio. They are used in systems such as radio and television broadcasting, radar, mobile phones, and satellite communications, for which they are in form of **dishes**.

Satellites are machines launched into space to move around Earth or another celestial body. A communications satellite is basically a station which receives signals in a given frequency and then retransmits them at a different frequency to avoid interference problems. The first satellite was launched by the Soviet Union in 1957. There are different types of satellites: low-orbit satellites, which travel at about 300 km from the Earth and observe the planet, providing accurate information about agriculture, pollution and weather **forecasting**; medium-altitude satellites, which travel at about 9000-18000 km from the Earth and are used in telecommunications.

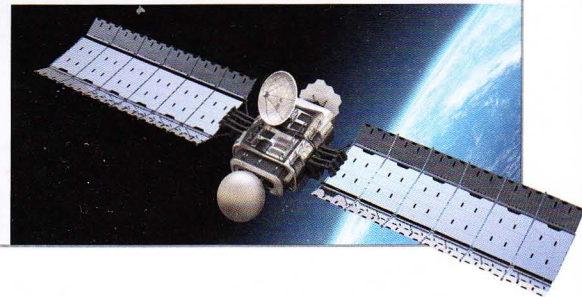

Means of transmission	Material	Function	Type of signal (ground or air)	Advantages
wires				
coaxial cables				
optical fibres				
antennas				
satellites				

4 Read the text about networks and answer the questions.



A network is a group of computers **linked** together. It consists of at least two computers joined by cables on the same desk or same office, but it can also mean thousands of computers across the world. The users of a network can **share** hardware (scanner, printer, fax machine, etc.), access data in other people's computers and run other programs stored in the network although not installed on their own computer.

A network consists of:

- nodes, that is to say different computers and devices;
- a connecting medium, such as cables or a wireless connection;
- routers, which are special computers enabled to send messages;
- switches, that is to say devices which help to select a specific path to follow.

Networks can be connected in different ways according to the area they cover.

A LAN (Local Area Network) is generally located in a limited space, such as a building or a campus.

On the contrary, a WAN (Wide Area Network) operates in a larger area and it can reach most of the world, so it could be described as a collection of LANs all over the world.

The exchange of information in a network is controlled by communications protocols, which define the formats and rules that computers must follow when talking to one another.

Well-known communications protocols are Ethernet, which is a family of protocols used in LANs, and the Internet Protocol Suite, which is used in any computer network.

Computer networks offer many advantages. For example, they facilitate communication, allowing people to send emails and texts, make phone/video calls and videoconference. Furthermore, networks allow people to share files, data, and other types of information as users may access data and information stored on other computers in the network.

On the other hand, networks may be difficult to set up and may be insecure as computer **hackers** can send viruses or computer worms to the net computer. They may also interfere with other technologies, as power line communication strongly disturbs certain forms of radio communication and access technology such as ADSL.

1 What does a network consist of?

2 What is a router?

3 What is a LAN?

4 What is a WAN?

5 What is the function of communications protocols?

6 What is Ethernet used for?

7 What are the advantages of using a network?

8 What are the disadvantages of using a network?

5 Refer back to the text and write a summary of the components, pros and cons of networks and describe a situation in which a network can be very useful.

Network topologies

A network topology is the layout of the interconnections of the nodes of a computer network. It depends on the distance involved, the type of hardware used and the stability needed.

- 6  9 Read the texts about the different network topologies and fill in the gaps with the words in the box. Then listen and check.

~~nodes~~ circle network pathway affect configure
small destination star failure exchanging backbone

Bus network

In a bus network all (1) *nodes* are connected to a common medium, called **backbone**, as it happens with Christmas lights. Information sent along the (2) _____ travels until

the destination is reached. This kind of topology is generally used only for (3) _____ networks, as it isn't able to connect a large number of computers. The main advantage offered by this topology is that if a computer or device doesn't work, it doesn't (4) _____ the others.

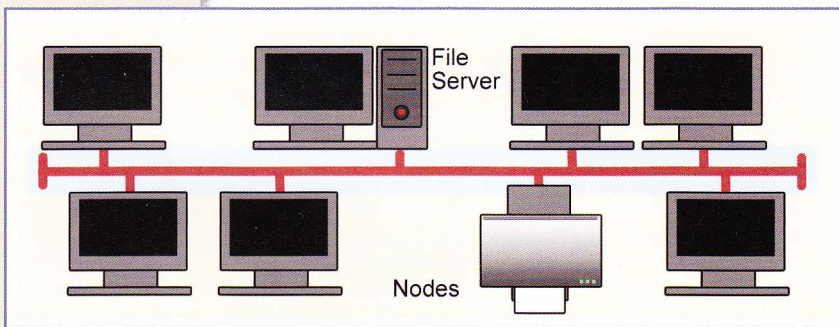

Star network

In a star network all nodes are connected to a special central node called the **hub**. Once it has received a signal, the hub passes it to all the other nodes until it reaches the (5) _____ computer. This means that all the computers and devices are joined together. This topology is commonly used in businesses because it can **grant** rapidity and safety in (6) _____ data. Thanks to this topology, data is always **up-to-date** and if a computer doesn't work, it doesn't affect the others.

The only disadvantage to it is that if the hub goes down, the whole (7) _____ doesn't work.

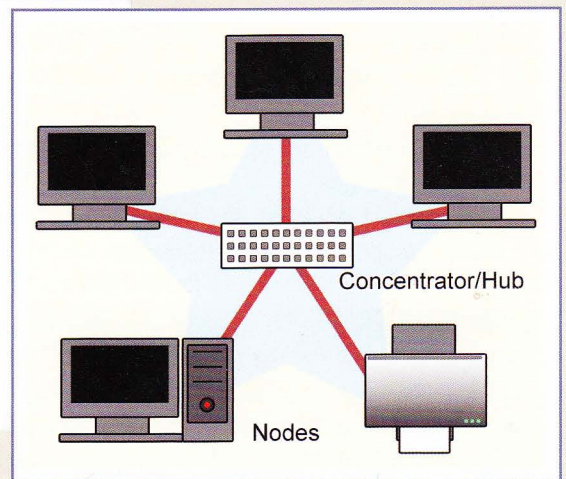

- 7 Read the texts again and decide if the following statements are true (T) or false (F), then correct the false ones.

- 1 The topology chosen depends only on the location of computers. _____
- 2 All topologies use many cables and are very expensive. _____
- 3 In a bus topology all the buses are connected one after the other. _____
- 4 In a bus topology a server controls the flow of data. _____
- 5 In a star network data is always updated. _____
- 6 The hub doesn't connect printers and other devices in a star topology. _____
- 7 In the ring topology each node is connected to the hub. _____
- 8 In the ring topology if the hub doesn't work, the network goes down. _____
- 9 Star bus topology combines elements of bus and ring topologies. _____
- 10 In a star bus topology a backbone line failure affects the whole network. _____

8 Read the texts again and complete the table with the missing information.

Topology	Connection	Use	Advantages	Disadvantages
		<i>small networks</i>		
	<i>Each node is connected to the central hub.</i>			
<i>ring</i>				

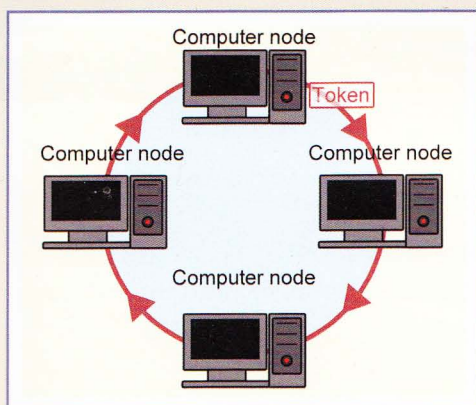

Ring network

In a ring network each node is connected to its left in a (8) _____. There is no central hub that holds all the data, and communication is sent in one direction around the ring through the use of a **token**. As it requires fewer cables, this topology is less expensive. Nonetheless, because it provides only one (9) _____ among the nodes, a single node (10) _____ may isolate all the devices attached to the ring.

Star bus topology

Star bus topology is the most common network topology used today. It combines elements of star and bus topologies to create a more effective network. Computers in a specific area are connected to hubs creating a (11) _____, then each hub is connected together along the network backbone.

The main advantage of this type of topology is that it can be more easily expanded over time than a bus or a star. On the other hand, this topology is more difficult to (12) _____ than the others and if the backbone line breaks, the whole network **goes down**.

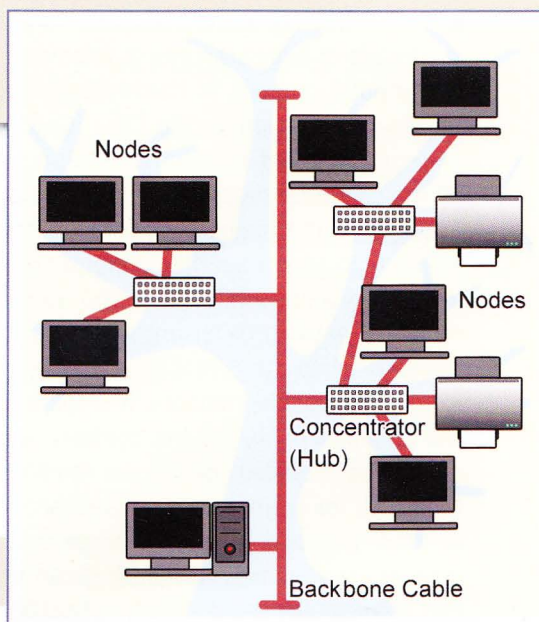

MY GLOSSARY

backbone /bækbəʊn/ _____
 bending /bendɪŋ/ _____
 coaxial /kəʊ'æksɪəl/ _____
 dish /dɪʃ/ _____
 forecasting /fə'kɑ:stɪŋ/ _____
 to go down /tə gəʊ daʊn/ _____
 to grant /tə grɑ:nt/ _____
 hub /hʌb/ _____
 inner /ɪnə(r)/ _____
 to link /tə lɪŋk/ _____
 to reach /tə ri:tʃ/ _____

receiver /rɪ'si:və(r)/ _____
 sensing device /sensɪŋ drɪvɪs/ _____
 to share /tə ʃeə(r)/ _____
 shield /ʃi:ld/ _____
 strand /strænd/ _____
 to surround /tə sə'raʊnd/ _____
 token /'təʊkən/ _____
 transmitter /trænz'mɪtə(r)/ _____
 to twist /tə twɪst/ _____
 up-to-date /ʌptədeɪt/ _____
 woven /wəʊvən/ _____

9

Computer technology

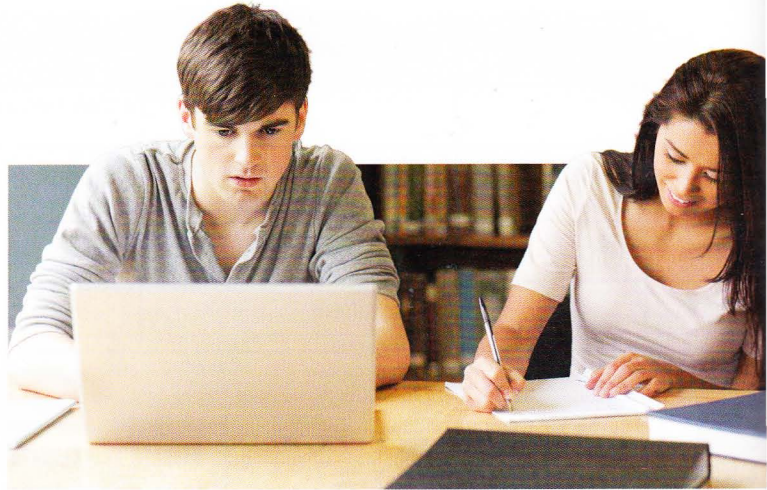

1 How much do you know about computers? Work in pairs and answer the questions.

- 1 What is a computer?
- 2 What does a computer do?
- 3 What are the main components of a computer?
- 4 Have you got a computer at home? What type is it?
- 5 What do you generally use your computer for?

2 Read the text about computer components and complete the table.

A computer is an electronic device that **performs** high-speed mathematical or logical operations and executes instructions in a program. Its main functions are to accept and **process** data to produce results, store information and programs and show results.

The main characteristics of these powerful machines are:

- speed, as they can execute billions of operations per second
- high **reliability** in the elaboration and delivery of data
- **storage** of huge amounts of information

A computer consists of hardware and software. The word hardware refers to all the components you can physically see such as the CPU (Central Processing Unit), the internal memory system, the mass storage system, the peripherals (input and output devices) and the connecting system. Software, instead, comprises all the computer programs and related data that provide the instructions for a computer to work properly.

The CPU is the brains of your computer and consists of ALU (Arithmetic Logic Unit), which carries out the instructions of a program to perform arithmetical and logical operations, and CU (Control Unit), which controls the system and coordinates all the operations. In order to memorise input and output data, there is an internal memory that can be distinguished into volatile and non-volatile. Volatile memory is memory that loses its contents when the computer or hardware device is off. Computer RAM (Random Access Memory) is a good example of volatile memory. It is the main memory of the computer where all data can be stored as long as the machine is on. On the contrary, a non-volatile memory contains information, data and programs that cannot be modified, or can be modified only very slowly and with difficulty. Computer ROM (Read Only Memory), for example, contains essential and permanent information and software which allow the computer to work properly. Memory **storage** devices are available in different options, sizes and capacities. These devices are extremely useful; they can be rewritten and offer incredible storage capacity, up to 256 GB. They can be magnetic (hard disks), optical (CDs and DVDs) or solid (flash memory cards).

Component (acronym)	Full name / Description	Functions and properties
hardware		
software		
CPU		
ALU		
CU		
RAM		
ROM		

Mass storage devices are available in an incredible number of options with different storage capacity up to 256 GB for some portable drives. A very popular type of **removable** device is represented by USB flash drives, which are much smaller and **lighter** than other portable drives, but which can still provide a huge storage capacity.

3  **10** Read the text about USB flash drives and fill in the gaps with the words in the box. Then listen and check.

plugged backup board moving disadvantage
operating system case off-site water pocket



A USB flash drive is a flash memory data storage device integrated with a USB (Universal Serial Bus) interface. USB flash drives are removable and rewritable, and they're small enough to be carried in a (1) _____. These portable drives are faster, have thousands of times more capacity, and are more durable and reliable than CD-ROMs because of their lack of (2) _____ parts.

Unlike most removable drives, a USB drive does not require **rebooting** after it's attached, they are very robust and use very little power. They just need to be (3) _____ into a USB port to work and they're compatible with any modern (4) _____, such as Linux, Mac OS X and Windows.

A flash drive consists of a small printed circuit (5) _____ carrying the circuit elements and a USB connector, insulated electrically and protected inside a plastic (6) _____.

The drive is often used as a (7) _____ medium to save data, because it is very **user-friendly** and it can be carried (8) _____ for safety despite being large enough for several **backups**. Moreover, flash drives are cheaper and less fragile than many other backup systems. Its only (9) _____ is that it can be easily lost because of its size and it's easy for people without a right to data to take **illicit** backups. Some specially manufactured flash drives are provided with a metal or rubber **case** designed to be **waterproof** and almost unbreakable. It's been tested that these flash drives can **retain** their memory even after being submerged in (10) _____, put in a **washing machine** and run over with a car.

4 Find the synonyms for the following words in the text.

- | | |
|-----------------------|----------------------|
| 1 long-lasting: _____ | 4 easy to use: _____ |
| 2 sturdy: _____ | 5 fabricated: _____ |
| 3 inserted: _____ | 6 hold: _____ |

5 Read the text again and decide if the following statements are true (T) or false (F), then correct the false ones.

- 1 Flash drives are provided with a very limited storage capacity. _____
- 2 They are lighter than other removable drives. _____
- 3 They need an external power supply to work. _____
- 4 USB flash drives are compatible with few operating systems. _____
- 5 A plastic case prevents the printed circuit board from being damaged. _____
- 6 USB drives are convenient for transferring data between computers or for personal backups. _____
- 7 They are more expensive than other backup systems. _____
- 8 Some models continue to work even after being accidentally dropped into water. _____

6 Read the text and complete the definitions with the words in the box.

mouse speaker modem **keyboard** **printer** disk drives monitor scanner

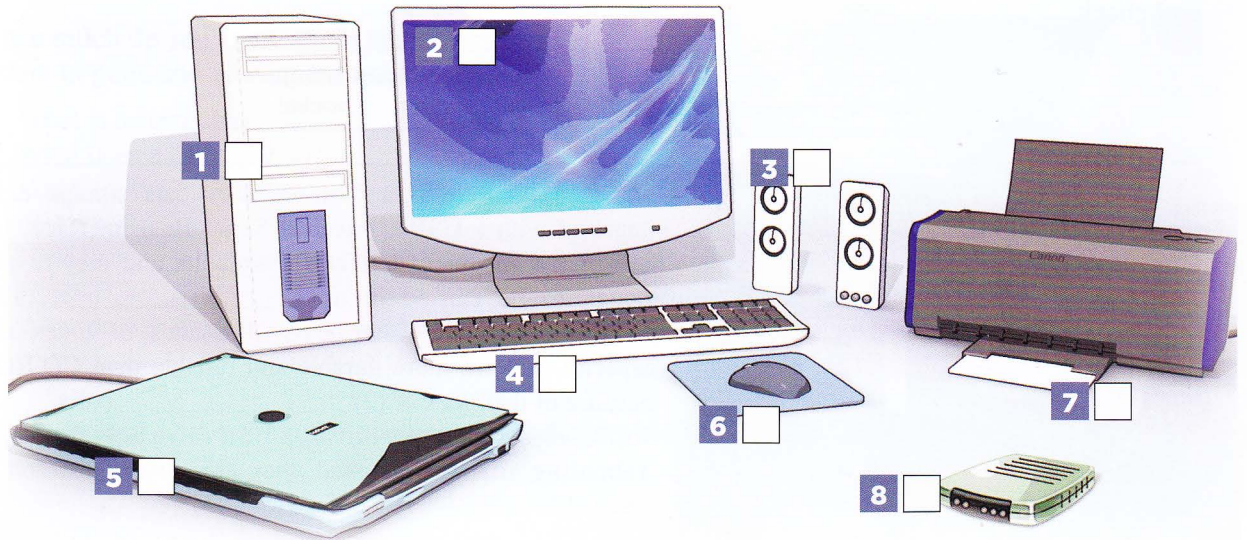

We call hardware the equipment involved in the functioning of a computer. It consists of several components that can either send data to the computer (input devices) or convert and transfer data out of the computer in the form of text, sound, image, or other media (output devices). The main input and output devices are:

(1) _____: this is the display, which helps you control computer operations. It accepts video signals from a computer and shows information on a screen. The first models used cathode ray tubes (CRTs), which was the dominant technology until they were replaced by liquid crystal displays (LCDs) in the 21st Century.

(2) _____: this is like a **typewriter** with an arrangement of **keys** corresponding to written symbols. It is generally used to type text and numbers in a word processor. However there are some special keys or combination of keys which, pressed simultaneously, can produce actions or computer commands.

(3) _____: this is a dynamic pointing device used to move the cursor on the screen. It consists of a plastic case, a little ball that sends impulses to the computer when rolled on a flat surface, one or more buttons, and a cable that connects the device to the computer. Modern computers are provided with built-in pointing devices that let you control the cursor by simply moving your finger over a pad.

(4) _____: this captures images from printed pages or photos and converts them into digital data. They usually come with software that lets you resize or modify a captured image.

(5) _____: this receives text and graphics from a computer and transfers the information to paper. It may vary in size, speed, **sophistication**, and cost. In general, more expensive models are used for higher-resolution colour printing.

(6) _____: this converts electrical signals into sounds and allows you to listen to music, multimedia web sites and conversations with other people.

(7) _____: this is a device or program that enables a computer to transmit data over telephone lines, by converting digital signals into analog waves. It can be either internal or external to your computer.

(8) _____: these are devices that allow you to read and write data on disks. They can be either mounted inside the computer and store the computer operating system and all the documents and programs, or come in the form of removable devices.

7 Work in pairs. Look at the picture in exercise 6 and decide if the components are input (I) or output (O) devices.

8 Read the descriptions of the different types of computers and match them with the correct picture.

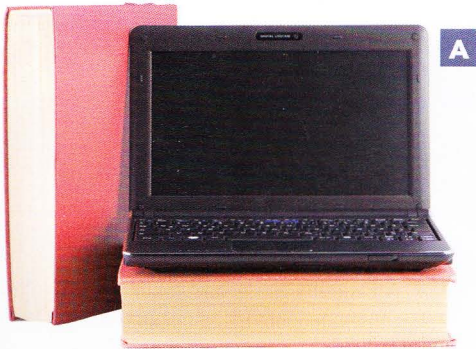

When you go to a computer shop, you can find computers for any use, size or capability.

- 1 **Desktop:** this is a personal computer intended for regular use at a single location. It's designed to sit on your desk, and as such it consists of a monitor and a **tower** with extra drives inside.
- 2 **Laptop:** this is a portable computer, which integrates all the usual components of a desktop computer into a single unit. Smaller versions of laptops are known as notebooks. It is useful for people who do not have a fixed place to work at. They are lighter and handier than desktop computers, but they also tend to be more expensive. They require an expensive battery that needs to be **recharged** quite often.
- 3 **Netbook:** this is a portable computer, with limited capabilities as compared to standard laptops. It is smaller and lighter, but it also has less processing power than a full-sized laptop. It is useful for people who don't have a fixed place to work at or for those who travel, but still need to surf the Net. They use a battery which needs to be recharged often.
- 4 **Palmtop:** this is a small portable computer designed to have large amounts of information **close to hand**. They are provided with light long-lasting batteries and special operating systems. They don't require any keyboard but use special pens or touch screens to enter data and access information.
- 5 **Mainframe:** this is a very large and expensive computer capable of supporting thousands of users at the same time. For this reason, it is used in businesses and it's the centre of computer networks. These super computers, which are usually as big as a large refrigerator, are the most powerful and expensive ones and they're used for jobs which require enormous amounts of calculations, such as weather forecasting, engineering design and economic data processing.

9 Read the texts again and answer the questions.

- 1 What does a desktop computer consist of?
- 2 Are desktop computers designed to be carried around?
- 3 Who are laptops useful for?
- 4 What is the difference between a netbook and a laptop?
- 5 How can you access or enter information on a palmtop?
- 6 What are mainframes used for?

The Internet

10 Read the text and complete the sentences with the missing information.

The Internet is a worldwide information system consisting of **countless** networks and computers, which allow millions of people to share information and data. Thanks to the Internet it is now possible for people all over the world to communicate with one another in a fast and cheap way.

The Internet was first invented in the 1960s in the USA by the Department of Defence as an internal project to **link** computers. The Department wanted an extremely safe way of sending messages in case of nuclear attack. It was a British physicist, Sir Timothy Berners-Lee, who used it to make information available to



everyone and created the most important media of the 21st century. In 1980 while working at CERN in Geneva – the largest particle physics laboratory in the world – he first thought of using hypertext to share and update information among researchers. Then in 1989-90 he produced a plan to link hypertext to the Internet to create the World Wide Web. He designed and built the first site browser and editor, as well as the first web server called httpd (Hypertext Transfer Protocol Daemon). Hypertext are the words or chains of words in a text we can click on to be linked to new sites whose content is related to the words. But how does this global system work? It is a network of people and information linked together by telephone lines which are connected to computers. The applications are based on a client/server relationship, in which your computer is the client and a remote computer is the server. All you need to join this system is a computer, a normal telephone line, a modem and an account with an Internet Service Provider (ISP), a company that provides access to the Internet. A user buys a **subscription** to a service provider, which gives him/her an identifying username, a password and an email address. With a computer and a modem, the user can connect to the service provider's computer which gives access to many services, such as WWW (world wide web), emails and FTP (file transfer protocol).

- 1 The Internet allows people to _____
- 2 In the 1960s, the Internet was used _____
- 3 Thanks to Sir Timothy Berners-Lee _____
- 4 He created the World Wide Web by linking _____
- 5 All you need to access the Internet is _____
- 6 The ISP is _____

11 Write a summary of the text in exercise 10 following the flow chart.

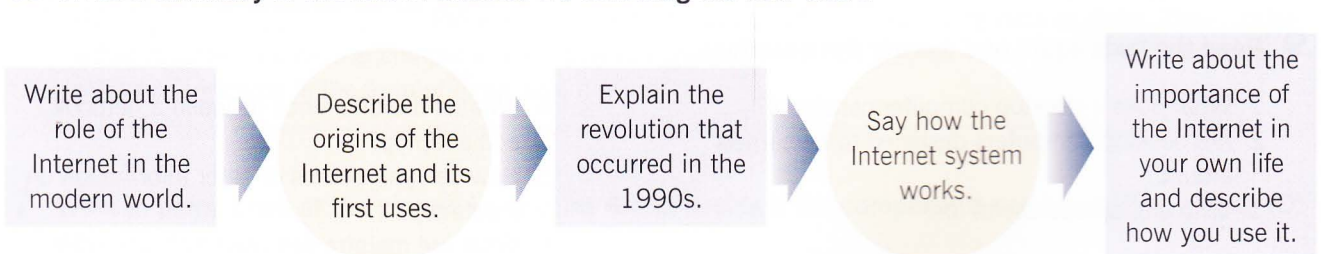

12 Read the text about the different types of Internet connections and match the words in the box with the correct definition.

DSL wireless satellite cable dial-up

- 1 _____
It used to be the most common way to access the Internet. This type of connection requires you to use a **landline** telephone connection and a modem connected to your computer. In order to establish the connection, you must dial a telephone number provided by the ISP. Nowadays it represents the cheapest but slowest way to connect to the Internet. Another disadvantage of this type of connection is that you cannot make or receive phone calls while connected to the Internet.
- 2 _____
A digital subscriber line is another way to connect to the Internet through a telephone connection, but the quality and speed of the connection is significantly greater than a dial-up connection. Moreover, unlike a dial-up connection, this connection is always on, which means you can still make and receive telephone calls with your landline telephone.
- 3 _____
In order to have this type of connection you must subscribe to an account with a local cable television provider and connect a cable modem to your computer. This connection is very fast and doesn't **interfere** with your telephone line.
- 4 _____
This is one of the newest Internet connection types. This connection does not require your computer to be connected to telephone or cable wires, as it uses radio frequency bands. You simply need a modem and an account with an Internet provider. Nowadays, many coffee shops, restaurants, public libraries and schools offer this type of connection for free. However, it is typically more expensive and mainly available in metropolitan areas.
- 5 _____
This type of connection allows a user to access the Internet via a satellite that orbits the earth. Because of the enormous distances signals must travel, this connection is slightly slower than terrestrial connections through cables. It represents an excellent option for people living in rural areas where other types of connections are not available.

MY GLOSSARY

backup /'bækʌp/ _____
 case /keɪs/ _____
 close to hand /kləʊs tə hænd/ _____
 countless /'kaʊntləs/ _____
 illicit /'ɪlɪsɪt/ _____
 to interfere /tu: ɪntə'fɪə(r)/ _____
 key /ki/ _____
 keyboard /'ki: bɔ:d/ _____
 landline /'lændlaɪn/ _____
 laptop /'læptɒp/ _____
 to link /tə lɪŋk/ _____
 mainframe /'meɪnfreɪm/ _____
 palmtop /'pɑ:mtɒp/ _____
 to perform /tə pə'fɔ:m/ _____
 printer /'prɪntə(r)/ _____

to process /tə 'prəʊses/ _____
 rebooting /ri:'bu:tiŋ/ _____
 to recharge /tə ri:tʃɑ:dʒ/ _____
 reliability /rɪ'laɪəbɪləti/ _____
 removable /rɪ'mu:vəbəl/ _____
 to retain /tə rɪ'teɪn/ _____
 sophistication /sə'fɪstɪ'keɪʃn/ _____
 storage /'stɔ:ɪdʒ/ _____
 subscription /sə'bskrɪpʃn/ _____
 tower /'taʊə(r)/ _____
 typewriter /'taɪpraɪtə(r)/ _____
 user-friendly /ju:zə'frendli/ _____
 washing machine /'wɒʃɪŋ mə'ʃi:n/ _____
 waterproof /'wɔ:təpru:f/ _____

1 Read the text about automation and match the words with their definition.

Mechanisation refers to the process of providing human beings with machinery capable of assisting them with the muscular **requirements** of work. A further development of mechanisation is represented by automation, which implies the use of control systems and information technologies to reduce the need for both physical and mental work to produce **goods**.

Automation has had a great impact on industries over the last century, changing the world economy from industrial jobs to service jobs. In **manufacturing**, where the process began, automation has meant that the desired results can be obtained through a series of instructions made automatically by the system, which define the actions to be done. Automated manufacturing grants higher consistency and quality, while reducing **lead times** and **handling**. It also improves **work flow** and increases the morale of workers when a good implementation of the automation is made.

However, the purpose of automation cannot be seen only in terms of a reduction of cost and time; there are several more aspects to be taken into consideration. For example, while it is true that automation offers a higher precision in the manufacturing process, it is also true that it requires skilled workers who can make repairs and manage the machinery.

The following table sums up the main advantages and disadvantages of automation:



Advantages	Disadvantages
Speeding up the developmental process of society	Disastrous effects on the environment (pollution, traffic, energy consumption)
Replacing human operators in tasks that involve hard physical or monotonous work	Sharp increase in unemployment rate due to machines replacing human beings
Saving time and money as human operators can be employed in higher-level work	Technical limitations as current technology is unable to automate all the desired tasks
Replacing human operators in tasks done in dangerous environments (fire, space, volcanoes, nuclear facilities, underwater)	Security threats as an automated system may have a limited level of intelligence and can make errors
Higher reliability and precision in performing tasks	Unpredictable costs due to research and development, which may exceed the cost saved by the automation itself
Economy improvement and higher productivity	High initial costs as the automation of a new product requires a large initial investment

- | | |
|----------------------------|---|
| 1 manufacturing | a <input type="checkbox"/> the time between the design of a product and its production |
| 2 information technologies | b <input type="checkbox"/> the amount of confidence that a group of people have |
| 3 goods | c <input type="checkbox"/> a set of tasks performed to complete a procedure |
| 4 service jobs | d <input type="checkbox"/> the process of packing and distributing goods |
| 5 skilled | e <input type="checkbox"/> the industry in which machinery is used to produce goods |
| 6 morale | f <input type="checkbox"/> the development and application of computer systems |
| 7 unemployment | g <input type="checkbox"/> having the knowledge and the ability to do something well |
| 8 lead times | h <input type="checkbox"/> things that are made to be sold |
| 9 handling | i <input type="checkbox"/> jobs in transports, communications, hospitals, energy industry, etc. |
| 10 work flow | j <input type="checkbox"/> the state of not having a job |

- 2 What would you like to automate in your life? In pairs, discuss the impact of automation on your own life and list its main advantages and disadvantages.
- 3 Read the text about automation technologies and answer the questions.

Numerical control over automated devices has resulted in a rapidly expanding range of applications and human activities. Computer-aided technologies (CAx) is a **broad** term that means the use of computer systems to **aid** in the design, analysis, and manufacture of products, by serving the basis for mathematical and organisational tools used to create complex systems. It includes computer-aided design (CAD software) and computer-aided manufacturing (CAM software).

The current limit of computer-aided technologies is that some abilities are well **beyond** the capabilities of modern mechanical and computer systems. Moreover, these technologies require high-skilled engineers and the synthesis of complex sensory data to work properly. As for costs involved, in some cases, automation is more expensive than mechanical approach.

Thanks to the incredible improvements in automation technology, a number of other technologies have developed from it, such as domotics and robotics.

Domotics is a field in building automation aimed at the application of automation technologies in households for the comfort and security of its residents. This means that lights, heating and conditioning systems, windows **shutters**, kitchen equipment and **surveillance** systems can be controlled by a remote control or even by a cell phone at a distance.

Robotics is a special branch of automation in which the automated machines have certain human features and are used to replace human workers in factory operations. Robots are computer-controlled mechanical devices that are programmed to move, manipulate objects and interact with the environment. **Nowadays** more and more sophisticated robots are being built to serve various practical purposes, for example in houses, businesses, in the **army** and for medical appliances for **disabled** people.

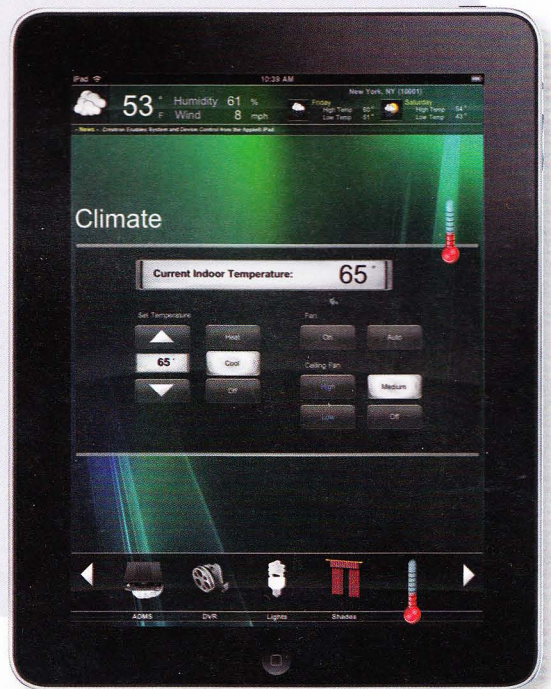

- 1 What does computer-aided technologies mean?
- 2 Which software does CAx include?
- 3 What are the current limits of CAx?
- 4 Can you name two applications of automation technologies?
- 5 How does a domotic house differ from a traditional house?
- 6 What are robots used for?

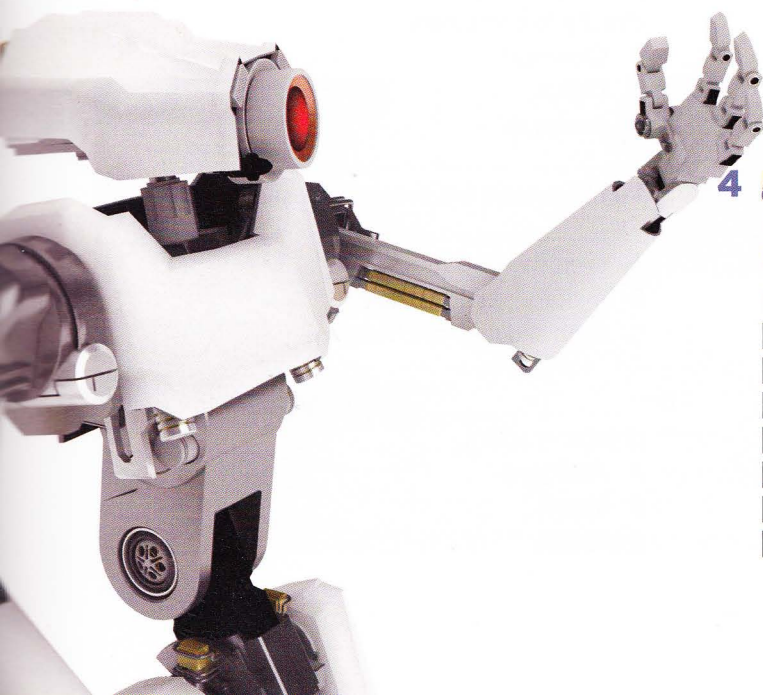

- 4 11 In pairs, think of what robots can do nowadays and tick the boxes below. Then listen and check your answers.

Nowadays robots can...

- | | |
|--|---|
| <input type="checkbox"/> get sick | <input type="checkbox"/> see obstacles |
| <input type="checkbox"/> go underwater | <input type="checkbox"/> speak fluently |
| <input type="checkbox"/> handle dangerous material | <input type="checkbox"/> smell things |
| <input type="checkbox"/> clean nuclear waste | <input type="checkbox"/> taste food |
| <input type="checkbox"/> explore volcanoes | <input type="checkbox"/> move objects |
| <input type="checkbox"/> go to space | <input type="checkbox"/> have feelings |
| <input type="checkbox"/> easily walk on two legs | |

Sensors

5 Read the text about sensors and match each paragraph with a heading.

Sensor applications Types of sensors What is a sensor?

1

Almost every industrial automated process requires the use of sensors and **transducers**, which are very advanced devices capable of measuring and sensing the environment and translating physical information (e.g. variations of light, pressure, temperature and position) into electrical signals. The sensor **picks up** the information to be measured and the transducer converts it into electrical signals that can be directly processed by the control unit of a system.

2

Because of the industrial and scientific importance of measuring, sensors are widely used in a variety of fields, such as medicine, engineering, robotics, biology and manufacturing. Traditional machines have difficulty measuring small differences in product size, so sensors can be particularly useful as they can **discriminate** down to 0,00013 millimetres. They can also detect temperature, humidity and pressure, acquire data and alter the manufacturing process. Sensors are also vital components of advanced machines, such as robots.

3

There are two types of sensors: analogue and digital. Analogue sensors operate with data represented by measured voltages or quantities, while digital ones have numeric or digital outputs which can be directly transmitted to computers.

The sensors usually employed in manufacturing are classified as mechanical, electrical, magnetic and thermal, but they can also be acoustic, chemical, optical and radiation sensors. Moreover, according to their method of sensing, they can be tactile or visual. Tactile sensors are sensitive to touch, force or pressure and they are used to measure and register the interaction between a contact surface and the environment. These sensors are used in innumerable everyday objects, such as **lift** buttons and lamps which turn on and off by touching the base. Visual sensors, instead, sense the presence, shape and movement of an object optically. They are becoming more and more important in surveillance systems, environment and disaster monitoring and military applications.

6 Read the text again and choose the correct answer.

- | | |
|---|---|
| 1 Sensors pick up _____ to be measured.
A electrical signals
B physical information
C the control unit | 4 _____ sensors can transmit data directly to computers.
A Chemical
B Digital
C Analogue |
| 2 Physical data is translated into electrical signals by _____.
A the transducer
B the sensor
C a computer | 5 Tactile sensors are commonly used in _____.
A everyday objects
B military applications
C sophisticated machinery |
| 3 Sensors _____ used to alter the manufacturing process.
A can't be
B are never
C can be | 6 _____ sensors are used to localise objects in space.
A Analogue
B Visual
C Tactile |

7  12 Read the text about the computer mouse and underline the correct option. Then listen and check.

A common example of the application of sensors to everyday objects is the computer mouse.

The mechanical mouse has a ball which rotates and translates the (1) *motion/temperature* of our hand into signals that the computer can use.

Developed in late 1999, the optical mouse is an advanced computer pointing device that uses a light-emitting **diode** (LED), an (2) *acoustic/optical* sensor and a digital signal processor (DSP) in place of the traditional mouse ball and electromechanical transducer. The optical mouse actually uses a tiny (3) *camera/recorder* to take thousands of pictures at a rate of more than 1,000 images per (4) *minute/second*.

Optical mice can work on many surfaces without a mouse pad, thanks to an LED that **bounces** light **off** the surface it is on onto an optical sensor. The sensor sends each image to a digital signal (5) *processor/transistor* which examines how the **patterns** have moved since the previous image, determining how far the mouse has moved. The computer then moves the cursor on the screen based on the coordinates received from the mouse. This happens hundreds of times each second, making the cursor appear to move very (6) *slowly/smoothly*.

The best surfaces reflect but some others, for example a blank sheet of white (7) *plastic/paper*, do not allow the sensor and DSP to work properly because the details are too small to be detected.

In addition to LEDs, a recent innovation are laser-based optical mice that detect more surface details compared to LED technology. This results in the ability to use a mouse on almost any surface and to (8) *reduce/increase* the resolution of the image.



8 Read the text again and match each sentence with its ending.

- | | |
|----------------------------|--|
| 1 A mechanical mouse | a <input type="checkbox"/> the optical mouse was developed. |
| 2 There are no sensors | b <input type="checkbox"/> provide high-resolution images. |
| 3 In late 1999 | c <input type="checkbox"/> can reflect light in the same way. |
| 4 An optical mouse | d <input type="checkbox"/> in a mechanical mouse. |
| 5 A DPS | e <input type="checkbox"/> has got a scroll ball mechanism inside. |
| 6 Not all surfaces | f <input type="checkbox"/> uses a light-emitting diode, an optical sensor and a DSP. |
| 7 Laser-based optical mice | g <input type="checkbox"/> is a processor for digital signals. |

MY GLOSSARY

to aid /tu: eɪd/ _____
 army /ɑ:mi/ _____
 beyond /brɪ'jɒnd/ _____
 to bounce off /tə baʊnts ɒf/ _____
 broad /brɔ:d/ _____
 diode /daɪəʊd/ _____
 disabled /dɪ'seɪbld/ _____
 to discriminate /tə dɪ'skrɪmɪneɪt/ _____
 to go underwater /tə ɡəʊ ʌndə'wɔ:tə(r)/ _____
 goods /ɡʊdz/ _____
 handling /hændlɪŋ/ _____
 lead times /li:d taɪms/ _____

lift /lɪft/ _____
 manufacturing /mænʃʊ'fæktʃərɪŋ/ _____
 nowadays /naʊədeɪz/ _____
 pattern /pætn/ _____
 to pick up /tə 'pɪk ʌp/ _____
 requirement /rɪ'kwəɪəmənt/ _____
 shutter /ʃʌtə(r)/ _____
 surveillance /sə'veɪlənts/ _____
 task /tɑ:sk/ _____
 transducer /trænz'dju:sə(r)/ _____
 unemployment rate /ʌnɪ'mplɔɪmənt reɪt/ _____
 work flow /wɜ:k fləʊ/ _____

1 Read the text about maintenance and answer the questions.

Any machine and device must be controlled regularly in order to avoid the risk of damage or breakdown of single parts **due to** long usage. Sometimes, if a proper maintenance is not done, a fault could occur, with negative consequences on the production process and on the workers' safety. The primary goal of maintenance is to avoid or mitigate the consequences of **failure** of equipment. This includes performing routine actions to keep

the device in working order and prevent the failure before it actually occurs (preventive maintenance), or fixing equipment after breakdown (corrective maintenance).

Preventive maintenance is designed to preserve and restore equipment reliability by replacing **worn** components before they actually fail. It includes maintenance activities such as partial or complete **overhauls** at specified periods, oil changes and **lubrication**. The ideal preventive maintenance is a combination of technical, administrative and managerial actions to prevent all equipment failure. If carried out properly, preventive maintenance can extend the life of the equipment.

Corrective maintenance, sometimes simply called 'repair', is carried out to get equipment working again. It **aims at** restoring the functionality of a machine so that it can continue to perform its work. This type of maintenance can be very expensive because sometimes equipment needs to be replaced, with substantial costs for the company.

Generally, maintenance is **scheduled** according to:

- the original equipment manufacturer's recommendations;
- codes and legislation within a country;
- **consultancy** advice;
- previous maintenance;
- most important measured values and performance indications.



- 1 Why is maintenance important?
- 2 What are the main types of maintenance?
- 3 What is the function of preventive maintenance?
- 4 Which activities does it include?
- 5 What is maintenance called if it occurs after a failure?
- 6 Why can corrective maintenance be expensive?

2 Read the text again and match the words with their definitions.

- | | |
|---------------|--|
| 1 fault | a <input type="checkbox"/> damaged and in poor condition as a result of much use |
| 2 to mitigate | b <input type="checkbox"/> a set of rules about how something must be done |
| 3 to fix | c <input type="checkbox"/> expert advice within a particular field |
| 4 overhaul | d <input type="checkbox"/> applying a greasy substance to reduce friction |
| 5 worn | e <input type="checkbox"/> a break or other defect in a piece of machinery |
| 6 lubrication | f <input type="checkbox"/> to do the necessary work to repair something that doesn't work properly |
| 7 code | g <input type="checkbox"/> to make something less severe or unpleasant |
| 8 consultancy | h <input type="checkbox"/> a careful examination of a machinery or system that must be repaired |

Auto maintenance

3 How well do you know the components of a car? Look at the picture and label each part with the words in the box.

seat battery radiator tyre spare wheel steering wheel
disk brake oil filter trunk windshield wiper

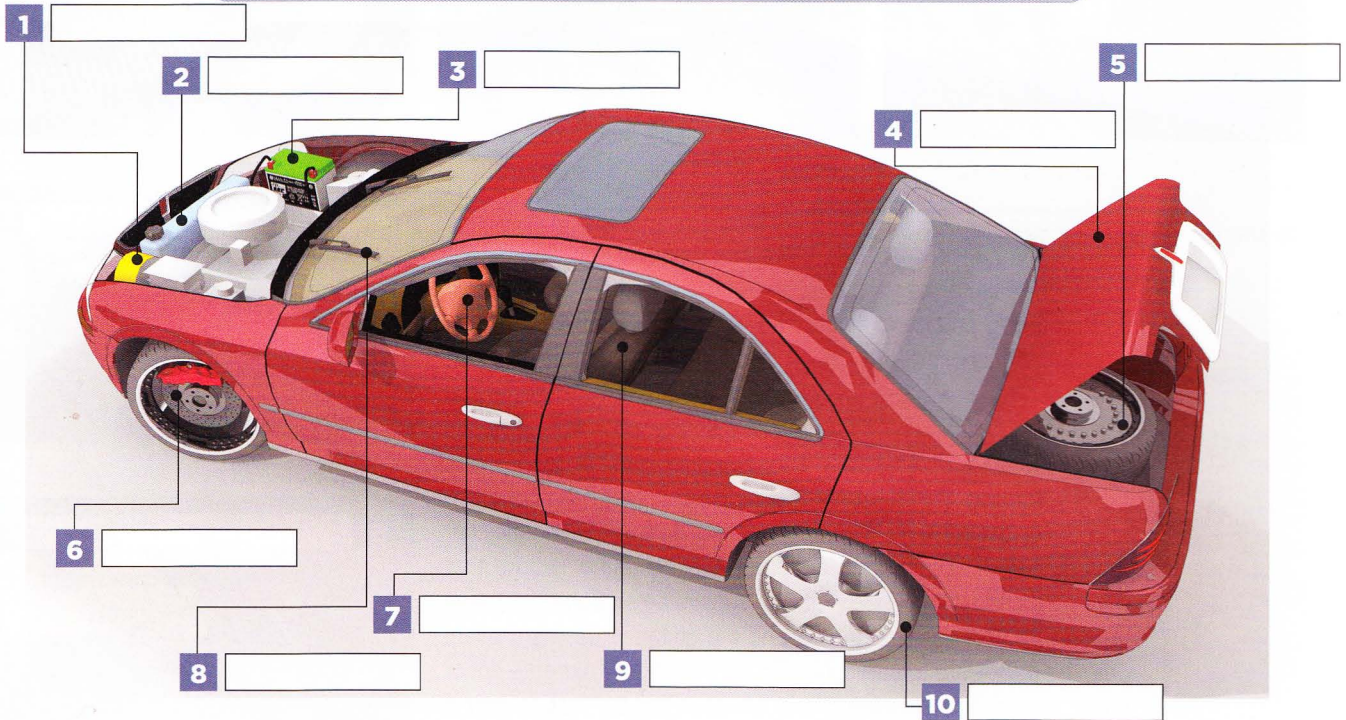

4 In pairs, take this quiz about car maintenance, then read the text to check your answers.

Cars are not just a luxury item to purchase one day and forget about until something happens. A properly maintained car not only lasts longer, but it is also less likely to break down unexpectedly. Take this quiz and test your knowledge of car maintenance!

- 1 Auto maintenance doesn't entail replacing fluids.
True False
- 2 It is not possible to do preventive maintenance to cars.
True False
- 3 Car maintenance must be scheduled keeping in mind different factors.
True False
- 4 The distance travelled every day doesn't affect the functionality of a car.
True False
- 5 If a car is exposed to extreme weather conditions it must be checked more often.
True False
- 6 It is not possible to replace windshield wipers.
True False
- 7 Brake fluid lasts forever.
True False
- 8 Car maintenance tasks should never be combined in one single service.
True False



5 Read the text and match the correct maintenance task with each picture.

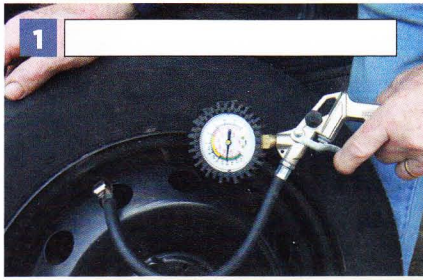

Auto maintenance describes the act of inspecting or testing the condition of car subsystems (e.g.: **engine**, brakes, radiator, etc.) and replacing parts and fluids. Thanks to regular maintenance it is possible to ensure the safety, reliability and comfort of a car, while during preventive maintenance, a number of parts are replaced to avoid major damage or for safety reasons.

Car maintenance is usually scheduled according to different factors, such as the year or model of the car, its driving condition and driver **behaviour**. When scheduling auto maintenance, car manufacturers recommend keeping in mind some factors that may affect the functionality of car subsystems. Some of these factors are: the number of trips and the distance travelled every day; the **exposure** to particular climate conditions (extreme hot or cold); long-distance cruising and whether the car has to **tow** a **trailer** or other heavy loads.

Common car maintenance tasks include:

- car wash
- check or replace the engine oil and oil filters
- inspect or replace windshield wipers
- inspect tyre pressure and **wear**
- check wheel **alignment**
- check, clean or replace battery terminals
- inspect or replace **brake pads** and fluids
- inspect or replace air filter
- lubricate **locks** and **hinges**
- check all lights
- inspect or replace **spark plugs**
- **tighten chassis bolts**

Some tasks that have equivalent service intervals can be combined into one single service known as a tune-up. In modern cars, where electronics control most of the car's functions, the traditional tune-up has been replaced by incorporated software that takes care of the engine by constantly checking thousands of sensor signals. Completed maintenance services are then recorded in a **service book** which is very useful for keeping track of the car service history.

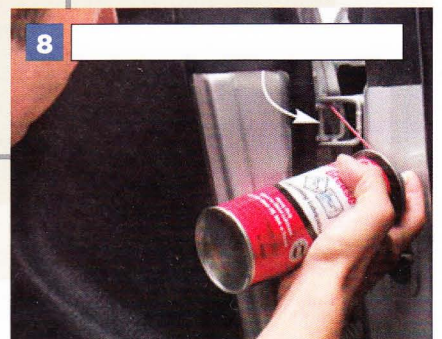
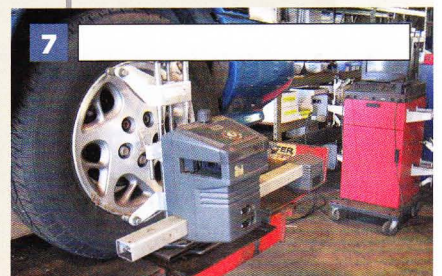

6  **13** Listen to the dialogue between Mrs Farrell and her mechanic and complete it with the missing words.

- Mechanic** Good afternoon, Mrs Farrell.
Mrs Farrell Good afternoon, John. How are you?
Mechanic I'm fine, thank you. How can I (1) *help* you?
Mrs Farrell Well, I need a complete (2) _____ for my car. Next week my husband and I are going on holiday by car. It's going to be a long journey all the way to Spain and I want my car to be in (3) _____.
Mechanic Sure. No problem. Have you checked your car recently?
Mrs Farrell Let me think... It must have been last year, in June, when the car wouldn't (4) _____. Anyway, it should all be written in the (5) _____. It's in the **glove compartment**.
Mechanic OK, I'll take it. Let's see... Oh, yes, it was the battery and I changed it. Are there any problems at the moment?
Mrs Farrell Not really, but I think the (6) _____ needs to be replaced.
Mechanic Sure. I'll check the filters too.
Mrs Farrell Yes, I think it's a good idea. Could you (7) _____ the tyres as well? And maybe wash it; it's so dirty. Well, John, when do you think the car will be ready?
Mechanic Actually, I'm quite busy at the moment, Mrs Farrell, so I could give it back to you next Friday. Would that be convenient for you?
Mrs Farrell Yes, it'd be perfect, because we're leaving on Sunday. I'll call you on Tuesday for a confirmation then.
Mechanic All right. Goodbye, Mrs Farrell.
on Friday...
Mechanic Good morning, Mrs Farrell. Here are your keys. I replaced the engine oil and the (8) _____. Then I checked the tyres and the brakes too. I had to (9) _____ the spark plugs because they were **fouled**. I also (10) _____ the electronics and then I washed the car. Now everything is OK, you can **set off** with no worries.
Mrs Farrell That's great! Thank you very much, John.

7 Read the dialogue again and answer the questions.

- 1 What does Mrs Farrell want?
- 2 Why does she need a complete tune-up?
- 3 What is written in the service book?
- 4 What does the car need to be done?
- 5 When will the car be ready?
- 6 What did John replace in the car?

MY GLOSSARY

to aim at /tu: eim ət/ _____
 alignment /ə'laɪnmənt/ _____
 behaviour /br'heɪvjə(r)/ _____
 bolt /bɔʊlt/ _____
 brake /breɪk/ _____
 brake pad /breɪk pæd/ _____
 chassis /'ʃæsi/ _____
 consultancy /kən'sʌltəntsi/ _____
 due to /dju: tə/ _____
 to entail /tu: m'teɪl/ _____
 exposure /ɪk'spəʊʒə(r)/ _____
 failure /feɪljə(r)/ _____
 fouled /faʊld/ _____
 glove compartment /glʌv kəm'pɑ:tmənt/ _____
 hinge /hɪndʒ/ _____
 lock /lɒk/ _____

lubrication /lu:b'rɪkeɪʃn/ _____
 overhaul /əʊvəhɔ:l/ _____
 to schedule /tə 'ʃedju:l/ _____
 service book /sɜ:vɪs bʊk/ _____
 to set off /tə set ɒf/ _____
 spare wheel /speə(r) wi:l/ _____
 spark plug /spɑ:k plʌg/ _____
 steering wheel /stiəriŋ wi:l/ _____
 to tighten /tə 'taɪtn/ _____
 to tow /tə təʊ/ _____
 trailer /treɪlə(r)/ _____
 trunk /trʌŋk/ _____
 tyre /taɪə(r)/ _____
 wear /weə(r)/ _____
 windshield /wɪndʃi:ld/ _____
 worn /wɔ:n/ _____

1 Read the text about health and safety at work and answer the questions.

Attention must be paid to **safety** in order to ensure a safe working practice in factories. Workers must be aware of the dangers and risks that exist all around them: two out of every three industrial accidents are caused by individual **carelessness**. In order to avoid or reduce accidents, both protective and **precautionary** measures must be followed while working.

Each country has specific regulations concerning health and safety at work. For example, The Health and Safety at Work Act 1974 is a UK Act of Parliament that establishes the fundamental rules to enforce workplace health, safety and welfare within the United Kingdom.

The objectives of the Act are:

- to secure the health, safety and welfare of people at work;
- to protect people in the work place against risks to health or safety in connection to their work activities;
- to control the keeping and use of dangerous substances;
- to control the emission of dangerous gases into the atmosphere.

The Act defines general duties of **employers, employees, suppliers** of goods and substances for use at work, and people who manage and maintain work premises. In particular, every employer has to ensure the health, safety and welfare at work of all the employees, visitors, the general public and clients. Employers have to ensure the absence of risk to health in connection with the use, handling or storage of items and substances, as well as provide adequate facilities for a safe working environment. It is also very important to provide employees with proper instructions and training so that they will be able **to cope with** any problem that may occur at work.

Employees, on their part, should always behave responsibly at work and take care of themselves and other people who may be affected by their actions. Moreover, they should cooperate with employers to **enable** them to perform their duties or requirements under the Act.

- 1 Why is it important to ensure a safe working environment?
- 2 Which law regulates workers' welfare in the United Kingdom?
- 3 What does the Act define?
- 4 What are the duties of employers?
- 5 Why is it important to provide employees with adequate training?
- 6 How can employees contribute to a safe working environment?

2 Read the text again and match the words with their definitions.

- | | |
|-------------------------|--|
| 1 precautionary measure | a <input type="checkbox"/> a responsibility or task that you have to do as part of your job |
| 2 carelessness | b <input type="checkbox"/> to deal effectively with a difficult situation |
| 3 welfare | c <input type="checkbox"/> the buildings and land occupied by a business |
| 4 duty | d <input type="checkbox"/> poor attention to an activity, which results in harm or errors |
| 5 premises | e <input type="checkbox"/> action taken in order to prevent something dangerous from happening |
| 6 to cope with | f <input type="checkbox"/> the health, comfort and well-being of a person or group |



3 14 This is an example of safety rules established by the workers' safety committee in a factory in Adelaide, Australia. Read the text and complete it with the words in the box, then listen and check.

operate tidy fire gloves concentration first aid protection brush

SAFETY RULES

MACHINERY

- Be sure to understand how to (1) *operate* every machine you are going to use.
- Never use machinery when you are in a room alone.
- Use all the (2) _____ required in the place of work.
- Check that the safety devices are working. If they are not working, ask for them to be repaired immediately.
- Do not talk to anybody who is operating a machine. (3) _____ is important at all times.
- Turn off the electricity before cleaning a machine.

TOOLS

- Report any damage to the tools used at work.
- See that tools are correctly set.

DRESS

- Before starting work, wear protective clothing.
- Always wear safety glasses, (4) _____ and boots when using a machine.

WORKSHOP

- Keep the workshop (5) _____, do not leave rubbish around and do not throw cigarette ends or **ashes** into the rubbish bin.
- The area around machines must be kept clear to avoid falling.
- Tools and protective clothing should be put away when not in use.
- Clean machines after use with a (6) _____ not with your hands.

ACCIDENT PROCEDURES

- Make sure you know where to **assemble** in the event of (7) _____ and where the emergency stop buttons are located.
- Check where the **fire extinguishers** are in your workplace and how they work, in order to be able to use them in case of fire.
- Do not shout or run as this can lead to panic, and inform the supervisor immediately if any accident occurs.
- Never administer (8) _____ unless you have been trained to do so.

4 Read the text again and decide if the following rules are true (T) or false (F), then correct the false ones.

- Use machinery only when other people are in the workplace. _____
- People mustn't talk in the workplace. _____
- Turn off electricity after a machine has been cleaned. _____
- Wear safety boots before arriving in a workplace. _____
- Always wear sunglasses when using a machine. _____
- Damaged tools can be dangerous. _____
- Report to the supervisor about damaged equipment. _____
- In case of fire ask the supervisor where the emergency stop buttons are located. _____
- In case of fire shout to catch other people's attention. _____
- Anyone can give first aid in case of an accident. _____

5 Read the text about safety signs and colours and complete the table with the correct sign category.

Safety **signs** and colours are useful tools to help protect the health and safety of employees and workplace visitors. Safety signs are used to draw attention to health and safety **hazards**, to point out hazards which may not be obvious and to remind employees where personal protective equipment must be worn.

Colour attracts attention and can be used extensively for safety purposes. For example, colour can be used as an additional safety measure to identify the contents of pipes and the nature of the hazard.



Different combinations of colours are used to indicate the various types of hazards. For example, the colour red is used to indicate a definite hazard, while a potential hazard is communicated by the colour yellow.

When employees are aware of the hazards around them and take the necessary precautions, the possibility of an **injury**, illness or other loss is minimised.

As shown in the table below, there are three basic sign categories used in the workplace:

- warning, to indicate definite or potential hazards;
- regulatory, to indicate which actions are prohibited or mandatory;
- information, to provide general information and directions.

Each category is distinguished by its shape and can be divided into subcategories having different colours.

Category	Subcategory	Colour
 1 _____ A circle indicates that an order is in force.	- Prohibition: it forbids an action. - Mandatory: it requires an action.	Red and black on white White on black
 2 _____ A triangle indicates caution or danger.	- Caution: it indicates a potential hazard. - Danger: it indicates a definite hazard.	Black on yellow White on red
 3 _____ A square indicates information.	- Emergency: it indicates first aid, health, fire protection and emergency equipment. - General information: it indicates permission or public information.	White on green White on blue

6 Match each sign with its meaning and write the correct subcategory for each of them.

- a slippery when wet
 b high voltage
 c first aid station
 d head protection must be worn
 e cafeteria
 f no smoking area

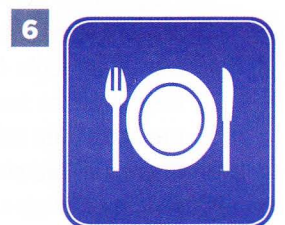

7 Read the texts about safety equipment and match the words in the box with the correct description.

hearing protection hard hats respirator safety glasses face shield **overall**

(1) _____ are the most important piece of safety equipment. There are many styles of these, but all share the same features, that is to say impact resistant **lenses** and side screens to protect against dust.



(2) _____ should be worn when working with **loud** power tools and machinery, in order to protect you from long-term hearing loss.



(3) _____ are predominantly used in workplace environments such as **building sites**. They protect the head from injury by falling objects, impact with other objects, **debris**, bad weather and electric shock.



When working with chemicals or machinery which makes dust, it is advisable to wear a face mask, to keep these fine particles away from the face. When spraying **varnish** or paint, a (4) _____ is a better choice, to protect you from any **harmful** effects of using these **chemicals**.



(5) A _____ must be worn when using machinery which gives off **sparks** or little parts. It is comfortable, can be **flipped up** when not needed, and will keep most of the flying chips away from your face.



When working, you should always wear proper clothing, like an (6) _____. Comfortable, **long-sleeved** shirts and long trousers combined with good safety boots will each provide a layer of protection.



8 15 Listen to the dialogues and complete the table with the equipment and the hazard mentioned.

Dialogue	Equipment	Hazard
1		
2		
3		
4		

9 Read the text about fire safety procedures and put the actions in the correct order.

A fire safety plan is required in all public buildings, from schools, hospitals, supermarkets to workplaces. Generally, the owner of the building is responsible for the preparation of a fire safety plan. Once the plan has been approved by the Chief Fire Official, the owner is responsible for training all staff in their duties.

Evacuation drills are a very important part of the staff training associated with emergency evacuation procedures. Drills should be carried out in all buildings at least once a year. The drill should be checked, recording the time required to complete the evacuation, and noting any problems and deficiencies. After each drill a meeting should be held to evaluate the success of the drill and to solve any problems that may have arisen.

What to do in case of fire...

- If you see fire or smoke, do not panic. Remain calm and move quickly, but do not run.
- Alert the responsible staff and telephone the correct national emergency number. Have someone meet the **firefighters** to tell them where the fire is. They can lose valuable minutes if they have to find it themselves.
- Rescue any people in immediate danger only if it is safe to do so.
- If practicable, close all doors and windows to contain the fire.
- Try to extinguish the fire using appropriate firefighting equipment only if you are trained and it is safe to do so.
- Follow the instructions of your supervisor and prepare to evacuate if necessary.
- Save **records** if possible.
- Evacuate your area and check all rooms, especially changing rooms, toilets, storage areas, etc.
- Do a head count of all staff and report any people unaccounted for to the supervisor.



- a Close all doors and windows.
- b Do a head count of all staff and visitors.
- c Evacuate your area and check all rooms.
- d Meet the firefighters and give them details about the fire.
- e Save records.
- f Prepare to evacuate.
- g Remain calm and move quickly.
- h Report any people unaccounted for to the supervisor.
- i Rescue any people in immediate danger.
- j Telephone the correct national emergency number.
- k Try to extinguish the fire using appropriate firefighting equipment.

MY GLOSSARY

ash /æʃ/ _____
 to assemble /tu: ə'sembəl/ _____
 building site /'bɪldɪŋ saɪt/ _____
 carelessness /keərləs'nəs/ _____
 chemicals /kɛmɪkəlz/ _____
 to cope with /tə kəʊp wɪð/ _____
 debris /deɪrɪ/ _____
 employee /ɪm'plɔɪi/ _____
 employer /ɪm'plɔɪə(r)/ _____
 to enable /tu: ɪ'neɪbəl/ _____
 evacuation drill /ɪvækju'eɪʃn drɪl/ _____
 fire extinguisher /'faɪə(r) ɪk'stɪŋgwɪʃə(r)/ _____
 fire fighter /'faɪə(r) faɪtə(r)/ _____
 to flip up /tə flɪp ʌp/ _____

harmful /'hɑ:mfəl/ _____
 hazard /'hæzəd/ _____
 injury /ɪn'dʒəri/ _____
 lens /lenz/ _____
 long-sleeved /lɒŋsli:vəd/ _____
 loud /laʊd/ _____
 overall /əʊvə'ɔ:l/ _____
 precautionary /prɪ'kɔ:ʃnəri/ _____
 record /rɛkɔ:d/ _____
 safety /seɪfti/ _____
 sign /saɪn/ _____
 spark /spɑ:k/ _____
 supplier /sə'plɑɪə(r)/ _____
 varnish /vɑ:nɪʃ/ _____

Symbol	Example	Meaning in full
.	3.14	three point one four
+	a + b	a plus b
-	c - d	c minus d
=	T = 24	T equals twenty four
x	3 x 10	three multiplied by ten / three times ten
:	16:8	sixteen divided by eight
%	10%	ten per cent
°	20°	twenty degrees
>	> 10	greater than ten
<	< 20	less than twenty
≤	≤12	less than or equal to twelve
≥	≥30	greater than or equal to thirty
√	√16	the square root of sixteen
n ^{2, 3, 4...}	10 ³	ten to the power of three
{ }		curly brackets
[]		square brackets
()		round brackets
∞	A ∞ B	A is proportional to B

Electrical Units

Name	Measurement of	Symbol
Volt	Electrical pressure	V
Ampere	Flow of electrons	A
Watt	Power	W
Ohm	Resistance of current flow	Ω
Hertz	Frequency	Hz

Conventional metric units

Name	Multiplication	Symbol
nano	10 ⁻⁹	n
micro	10 ⁻⁶	μ
milli	10 ⁻³	m
kilo	10 ³	k
mega	10 ⁶	M
giga	10 ⁹	G
tera	10 ¹²	T

Flash on English for Mechanics, Electronics and Technical Assistance

Editorial coordination: Simona Franzoni

Editorial department: Sabina Cedraro, Serena Polverino

Art Director: Marco Mercatali

Page design: Sergio Elisei

Picture Research: Giorgia D'Angelo

Production Manager: Francesco Capitano

Page layout: Sara Blasigh

Illustrated by Laura Bresciani

Cover

Cover design: Paola Lorenzetti

Photo: Shutterstock

© 2012 ELI S.r.l

P.O. Box 6

62019 Recanati

Italy

Tel. +39 071 750701

Fax. +39 071 977851

info@elionline.com

www.elionline.com

The publisher would like to thank Rebecca Raynes for her precious contribution.

No unauthorised photocopying.

All rights reserved. No part of this publication may be reproduced, stored in a retrieval system, or transmitted, in any form or by any means, electronic, mechanical, photocopying, recording or otherwise, without the prior written permission of ELI.

This book is sold subject to the condition that it shall not, by way of trade or otherwise, be lent, resold, hired out, or otherwise circulated without the publisher's prior consent in any form of binding or cover than that in which it is published and without a similar condition being imposed on the subsequent purchaser.

While every effort has been made to trace all the copyright holders, if any have been inadvertently overlooked the publisher will be pleased to make the necessary arrangements at the first opportunity.

Printed by Tecnostampa 12.83.229.0

ISBN 978-88-536-1449-0

Acknowledgements

ELI Archives: pp. 9, 35 (middle); Shutterstock: pp. 4, 5, 6, 7, 8, 10, 11, 12, 13, 15, 16, 19, 20 (top right), 21, 22, 23, 24, 28, 29, 31, 32, 34, 35 (bottom), 37, 38, 39 (bottom), 40, 42, 44, 45, 46.

FLASH on English

for MECHANICS, ELECTRONICS
& TECHNICAL ASSISTANCE

FLASH on English for MECHANICS, ELECTRONICS and TECHNICAL ASSISTANCE is specifically designed for students who are studying for a career in mechanics and engineering. It introduces the vocabulary and the language functions specific to this language sector, and includes practice exercises in all four skills.

Audio files in MP3 format are available online.

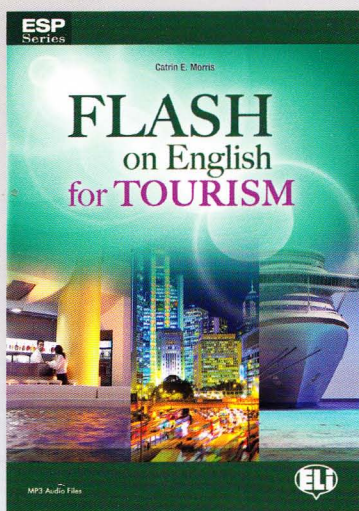

ISBN 978-88-536-1447-6

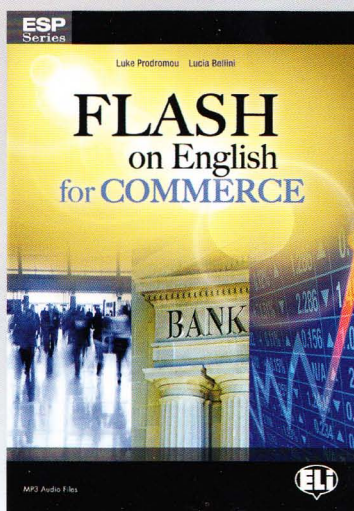

ISBN 978-88-536-1446-9

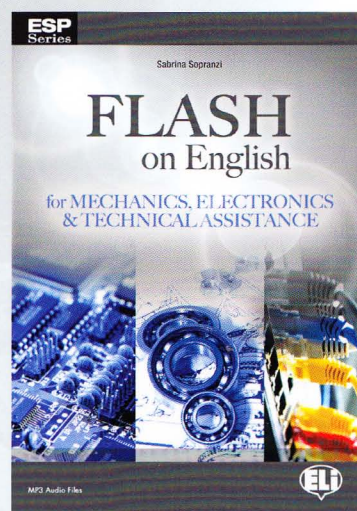

ISBN 978-88-536-1449-0

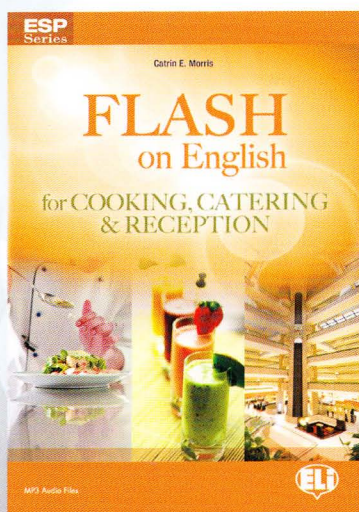

ISBN 978-88-536-1448-3

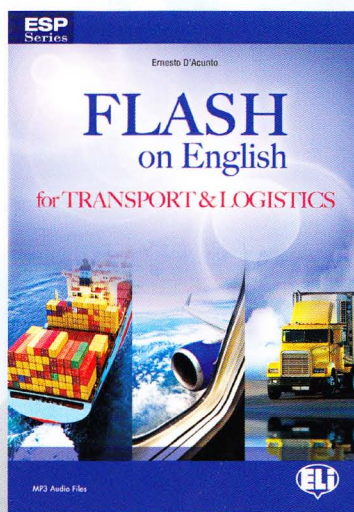

ISBN 978-88-536-1451-3

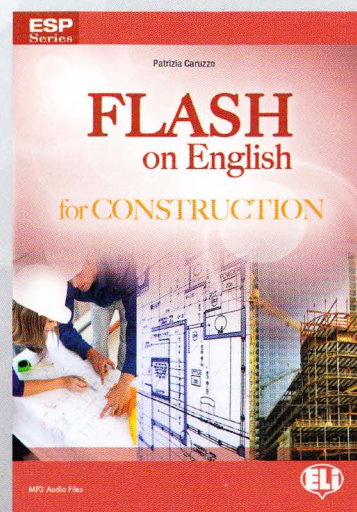

ISBN 978-88-536-1450-6

